

16
PROJECTS

5 TIPS FOR
A FAST
finish!



MAKE THIS
CUSHION IN
JUST ONE
AFTERNOON

“Just untie
the ribbon and
start cutting!”
DESIGNER KATE BASTI



PATCHWORK & **Quilting** *Sharing your passion for fabric!*

IMMEDIATE
MEDIA ^{CO}

ISSUE 87 2020

*Stay home
and sew*

EASY PEASY PIECING
TO KICK START YOUR
QUILTING MOJO

COLOUR POP
QUILT BLOCKS

Mix + match
for a quilty fix



PUPPY POWER

SEW SCRAP HAPPY STRIPED
SAUSAGE DOG SOFTIES

*Happy
faces*

Try our super-speedy
felt appliqué cushions
by Jane Foster



*Stash
friendly*

Simple modern
patterns for
Layer Cakes +
Jelly Rolls



atelierb 

**SMART, ELEGANT,
SOPHISTICATED**



The world's leading sewing machine manufacturer since 1921

JANOME
janome.co.uk

Meet the team

Editor Alice Hadley
Art Editor Kit Cheung
Operations Editor Lorna Slessor
Senior Technical Editor Sarah Griffiths
Senior Digital Editor Zoe Williams

Contributors

Alyce Blyth • Amanda Carye • Amanda McCabe
Bobbie Gentili • Debbie von Grabler Crozier • Jane Foster
Kate Basti • Kate Webber • Lou Orth
Lucy Ward • Sarah Griffiths • Susan Standen
Susi Bellingham • Tina Prior • Yasmeen K Branton

Photography Immediate Media Photo Studio unless otherwise stated.

Contact us

Love Patchwork & Quilting, Immediate Media, Eagle House, Colston Avenue, Bristol, BS1 4ST
lovequilting@immediate.co.uk

ADVERTISING

Call: 01173 008 203
Senior Advertising Manager Penny Stokes
Client Partnership Manager Beckie Pring
Senior Sales Executive Tiffany Jackson
Ad Coordinator Emily Thorne
Ad Designer Alfie Martin

MARKETING AND CIRCULATION

Direct Marketing Manager Joe Jones
Newstrade Marketing Manager Janine Smith

PRODUCTION

Production Controller Ian Wardle
Production Manager Emma McGuinness / Sian Rodgers
Production Director Sarah Powell

LICENSING

Director of International Licensing & Syndication Tim Hudson

PUBLISHING

Publishing Director Liz Taylor
liz.taylor@immediate.co.uk
Managing Director (Craft) Kerry Lawrence
Managing Director (Bristol) Andy Marshall
Chief Executive Officer Tom Bureau
Printed and bound by William Gibbons
Distributed in the UK by Frontline

BUYING

Karen Flannigan • Jennifer Morgan

SUBSCRIPTIONS

03330 162 145*
buysubscriptions.com/help



EASY-PEASY!

Whether you've found yourself with an abundance of hours to fill, or are snatching moments to yourself wherever you can get them, life on lockdown has certainly changed how we all perceive time! So it's serendipitous that this issue is filled with quick-sew projects that give you maximum results for minimum effort. Banish your cutting time by using pre-cuts, or whip up one of our super-simple patchwork projects for an almost-instant quilting fix. We're also sharing our top tips for quilting at home, so if you are looking for a longer-lasting project you can tackle some of those unfinished quilt tops with confidence. Whatever you're working on, we're sending you loads of love in these strange times.

Alice

Alice Hadley Editor

Join us online... we love to share!

[f LovePatchworkandQuilting](#) [i LoveQuiltingMag](#) [p LoveQuiltingMag](#)

www.gathered.how/lovequiltingmag



Immediate Media Company Bristol Limited (company number 05715415) is registered in England and Wales. The registered office of Immediate Media Company Bristol Limited is at Vineyard House, 44 Brook Green, London W6 7BT. All information contained in this magazine is for information only and is, as far as we are aware, correct at the time of going to press. Immediate Media Company Bristol Limited cannot accept any responsibility for errors or inaccuracies in such information. Readers are advised to contact manufacturers and retailers directly with regard to the price of products/services referred to in this magazine. If you submit unsolicited material to us, you automatically grant Immediate Media Company Bristol Limited a licence to publish your submission in whole or in part in all editions of the magazine, including licensed editions worldwide and in any physical or digital format throughout the world. Any material you submit is sent at your risk. Although every care is taken, neither Immediate Media Company Bristol Limited nor its employees agents or subcontractors shall be liable for loss or damage.

*Calls from landlines will cost up to 9p per minute. Call charges from mobile phones are included in free call packages. Outside of free call packages call charges from mobile phones will cost between 3p and 55p per minute. Calls from landlines will cost up to 9p per minute. Lines are open Mon to Fri 8am - 6pm and Sat 9am - 1pm.



Immediate Media Company Limited is working to ensure that all of its paper is sourced from well-managed forests. This magazine can be recycled, for use in newspapers and packaging. Please remove any gifts, samples or wrapping and dispose of it at your local collection point.

Meet our contributors!



Bobbie Gentili

Bobbie's lifelong creativity and love of mathematics has culminated in an obsession with making and designing her own unique quilts



Amanda McCabe

Amanda is a woodworker and modern quilt pattern designer who enjoys experimenting with bold lines and bright, punchy colour palettes



Jane Foster

Jane is an illustrator, author and textile designer who loves to create bold and playful designs that appeal to both kids and adults



Projects

RAINBOW WAVE

14 Earn your stripes and piece bold basics into graphic blocks

AIRFLOW

26 Grab a Jelly Roll... this sleek and sophisticated strip-pieced quilt can be ready in a weekend!

MODERN MOSAIC

34 Embrace your colour crush and whip up a Half-square Triangle quilt with an irresistible tonal finish

SILLY SAUSAGE

41 Bring a ditsy duo of canine softies to life in fabric scraps!

ALL THAT GLITTERS

48 Mix metallic fabrics with punchy piecing in a Bear Paw pattern that helps you make the most of your pre-cuts

PLAY TIME

58 Sew the perfect set-up for tummy time with playful print fabrics and a sweet sunshine design! This DIY play mat has it all

DENIM DAYS

63 Decorative stitches and pretty patches... give a pair of pre-loved jeans a quilty makeover. They're so easy to customise!

GOODNIGHT MOON

66 Sleep sweet with a pair of Foundation Paper Pieced pillows topped off with charming prints and a delicate moon phase design

FELT FRIENDS

73 Snip and stitch a pair of perky cushions with easy-use templates and fuss-free fabrics!

SASHIKO SHOPPER

79 Slow down and settle into some soothing hand stitching to add some swoon-worthy texture to a stylish tote bag

BLOCK OF THE MONTH

85 This issue we stitch up the appliqué Andra block in Yasmeen K Branton's Blomma Block of the Month series

Read the instructions all the way through before cutting any fabric. Always make a block before embarking on a large project. Please do not re-sell or distribute content without permission. Do not make any part of the templates or instructions available to others through a website or a third party website or copy it multiple times without our permission. Copyright law protects creative work and unauthorised copying is illegal. We appreciate your help.



79

SUBSCRIBE TODAY

Never miss an issue with a digital subscription!

24



26



73



34

Features

QUILTING READY

6 We've made sure you're set for quilting success with a bonus booklet filled with tips and tricks

OUT THERE

9 Each month we pick out our favourite new quilty finds. Fabrics, sewing accessories, book releases, patterns and homewares – if the team love it, you'll find it featured in these pages

IN THE KNOW

32 Whether you need a little help or simply love looking at a cheerful collection of fabrics, there are many benefits to working with bundles. Kate Basti unravels her reasons

DESIGNER PROFILE

54 Quilt pattern designer, sewing teacher and book author Alyce

Blyth can't resist passing on her knowledge. We chatted about why she loves mini quilts so much and how helping others comes naturally to her

NEXT MONTH

89 Your sneak peek at what we've got in store for you in the next issue of Love Patchwork & Quilting magazine

THE LAST WORD

90 Short on time? Luckily our back page columnist Amanda Carye's not short on ideas for speedy sewing sessions... Find out her favourite quick makes



Customise a pre-loved pair of jeans!

BLOCK
2 of 12

85



THE QUILT

**Machine quilting techniques,
troubleshooting and more!**

Featuring: Christine Maraccini, Alex Anderson, Don Linn,
Christina Cameli, Hari Walner and Angela Walters



QUILTING READY!

Time to transform your quilt top into the real deal? We've made sure you're all set for success, with a bonus booklet to help you on your quilting journey

You've finished your piecing, your quilt sandwich is nicely layered up and basted... it's time for some quilting! Check out our guide for techniques, troubleshooting and more. Top quilting experts – from Angela Walters to Christina Cameli – offer their experience and advice for every step from setting up your machine for best results to making the most of your quilted design ideas. Better yet, all of this is specifically tailored for use on your home sewing machine... who needs a longarm, right? Show us your quilting success on Instagram by tagging #lovequiltingmag. We love to see!



LovePatchworkandQuilting

LoveQuiltingMag

LoveQuiltingMag

www.gathered.how/lovequiltingmag



Get
10%
OFF EVERYTHING!
Discount code:
LPQ87



Moda: Bella Solids



Dashwood: Celeste



We're proud to stock all these leading brands!



Robert Kaufman:
Kona Solids



Craft Cotton Co.
Roald Dahl Matilda



Morris and Co. Mineral

FREE UK DELIVERY
on orders
over £25

www.woolwarehouse.co.uk
01926 882818 or 0800 505 3300 | hello@woolwarehouse.co.uk

No minimum order. £2.95 delivery charge for UK orders under £25.
* Discount code not valid on sale items.

Patterns
Fabrics
Notions



SEW HOT
sew you, sew now

10% Off
First Online
Order Use
Code LPQ

The Hottest New Trends in Sewing & Quilting



SewHot.co.uk

0330 111 3690 info@sewhot.co.uk
3B Holly Road, Thornton-Cleveleys, FY5 4HH

PATCHWORK & **Quilting**
Sharing your passion for fabric!

- Our readers spend over 6 hours patch working and/or quilting per week, with 49% also sewing for home and gifts!
- 80% say they find advertising useful and 83% regularly buy from independent shops or online retailers.
- Our readers love fabric, quilting patterns, accessories, craft courses and workshops*



*LP&Q reader survey - Jan 2015.

To find out how we can help to market your company,
PLEASE GIVE TIFFANY JACKSON
A CALL ON **01173 008 203**
TIFFANY.JACKSON@IMMEDIATE.CO.UK

OUT THERE



Holiday spirit

There's no time like the present to get ahead and start stitching for your favourite time of year. Lindsey Neill of Pen + Paper Patterns has brightened our days with a quartet of fresh quilt patterns, each one dedicated to a special holiday. From the quirky fireworks to the classic love hearts, cutesy spiders and mini Santa hats, each pattern is traditionally pieced and makes for a simple sewing project. Purchase the bundle and get all four for the price of three! Want more? Check out her holiday patterns from last year too. Find it all at penandpaperpatterns.etsy.com



DIY DESIGNS

Amy Van Luijk's latest fabric collection for FIGO Fabrics, DIY, is dedicated to the movers and makers. Dinky scissors, threads and rotary cutters meet abstract blenders in a range that's tied together with a pretty pastel palette. Pops of dramatic black give some of the prints a bold

twist, while small-scale tone-on-tone prints soften the edge. Fussy cutting opportunities are plentiful here – just think of the scrap storage and sewing-side organisation projects you could make with this range! Have a browse of the prints and coordinates at figofabrics.com

QUILT BUZZ

Buzz, buzz... what's that? There's a new podcast in town! Dreamed up by Amanda Carye of Broadcloth Studio, Anna Brown of Wax + Wane Studio and Wendy Chow of The.Weekend Quilter, the Quilt Buzz podcast is the place to go for answers to all the nitty-gritty questions you've ever wanted to ask your favourite quilters. Do you sew with shoes on? Who's your quilting crush? From the sensible queries to the downright silly suggestions, the witty trio leave no stones unturned. Listen to a range of episodes, from the likes of Shannon Fraser and Jenn McMillan to our very own Operations Editor Lorna of Cloth & Crescent! The podcast is available through Apple Podcasts, Spotify, Google Play and Stitcher.



GOOD READS

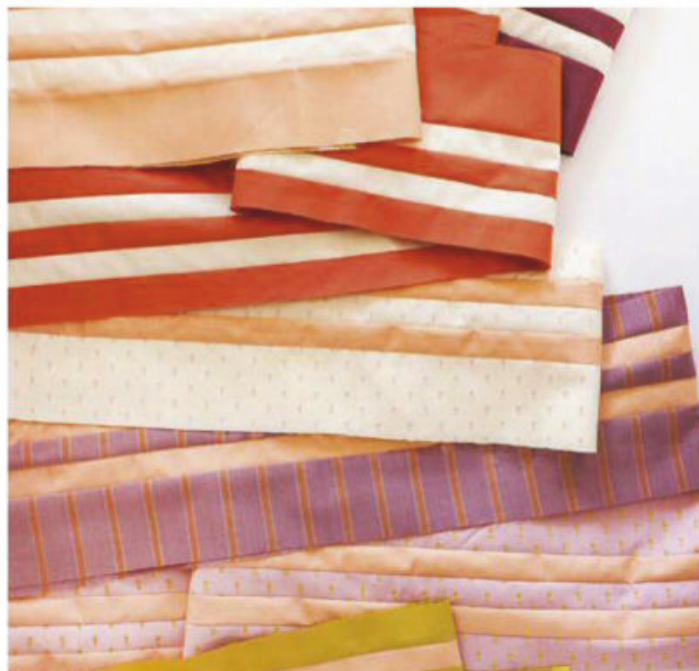

LET'S GROW

The first design in a series of four quilts to represent the seasons, Grow is the one of the latest must-make patterns from Suzy Quilts. Each design focuses on a sewing skill alongside a general life meditation to help you enjoy and make the most of the quilt-making process even more than usual (we've been told that's possible!). With the primary skills being strip piecing and pressing, Grow will teach you new techniques to keep your strips perfectly straight for a flawless finish. Keep an eye out for tonnes of extra advice on Suzy's blog too, plus videos and tutorials for quilting, binding and more! suzyquilts.com

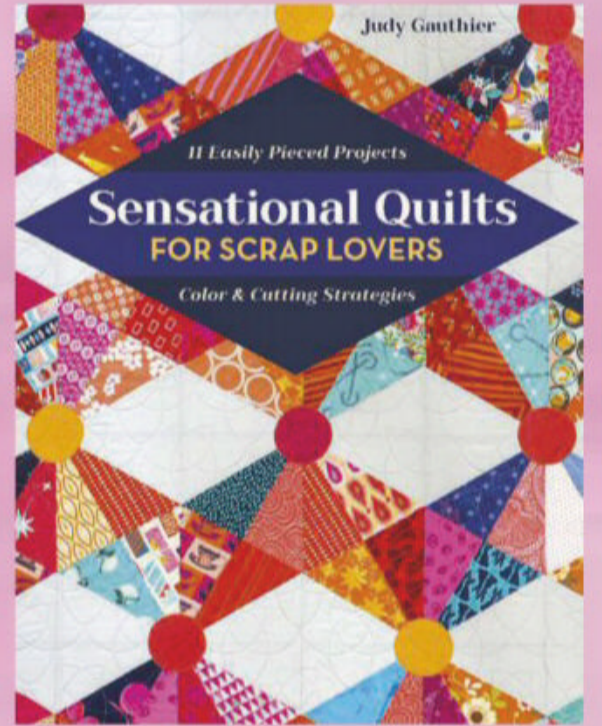

SCRAP HAPPY

We've all got them, but we may not all know what to do with them... enter Judy Gauthier! With eleven patterns to help you use even your smallest scraps, *Sensational Quilts for Scrap Lovers* will teach you how to make some magic with remnants in all shapes and sizes. ctpub.com



MINI MAKEOVER

If you're not already following colourful sewist Natalie Santini (aka Sew Hungry Hippie), then hotfoot it over to Instagram right this second. One of her latest treats for the quilting community is her mini ironing board cover video tutorial – your ironing board could look as cute as this Ruby Star Society version too! It'll transform your sewing space, trust us. Read more over at hungryhippiesews.com

TO DIE FOR

Good news, quilters: Crafter's Companion are taking all of the work out of cutting for us. Take a look at their new patchwork dies! With nesting sets of hexagons, half hexies, diamonds and equilateral triangles, you can cut countless fabric shapes with just a quick run through a die-cutting machine. Just think of how many quilts you'll have the time to make now... who needs a rotary cutter?! crafterscompanion.co.uk

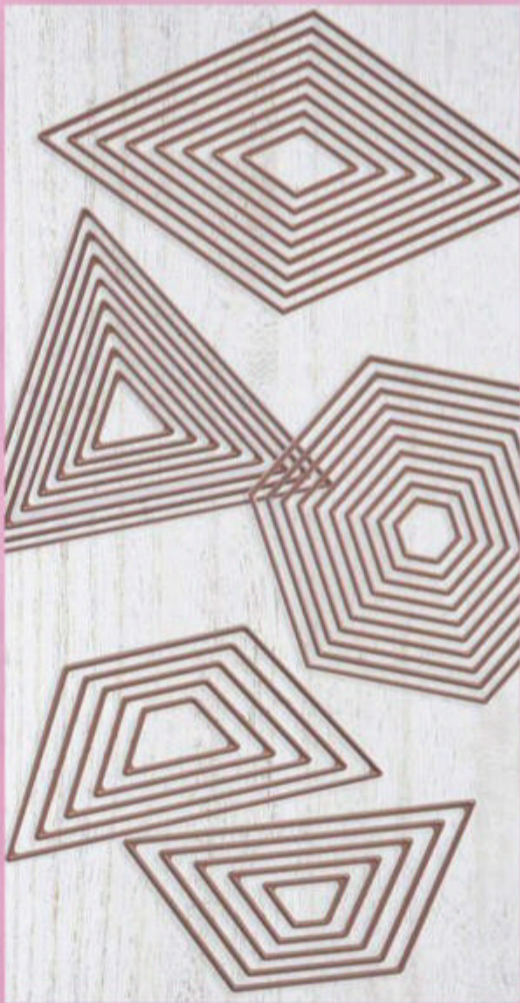

DESERT VIBES

Art Gallery Fabrics are heading southwest with their latest capsule collection, Pacha. Sketched animals etch their way through a monochrome landscape, complete with on-trend cacti and stylish sunsets. Geometric patterns meet nature-inspired prints, while the

simple black and white palette really lets the designs shine. Pops of sage green, soft peach and warm mustard add an extra element of fun to the stylised fabrics, decorating the llama's coats and the critter's blushing cheeks. You can't get cuter! artgalleryfabrics.com



@machelwithana

INSTA INSPIRES!

#MINISERIESSAL

Quilty powerhouses Giuseppe Ribaudo (@giucy_giuce) and Alison Glass (@alisonglass) joined forces to host the Mini Series Sewalong, featuring their teeny tiny (and super adorable) Foundation Paper Pieced blocks. With over 2,000 stitchers joining in, our Instagram feeds have been inundated with blocks that are as miniscule as they are creative. From Courthouse Steps to the classic Pineapple, there are eight dinky designs to get stuck into!



@eloominatedesigns



Cathedral (LB 188) - 80"x88" - FQ Friendly



Modern Herringbone (LB 187) - 63"x73" - HB Friendly

Bloomington

Lella Boutique

bloom where you are planted

It's springtime in the countryside; the meadows are dotted with flowers, the birds are serenading, and there is a distinct fragrance of earth and rain mixed together. Everything is lush and green—the gardens dressed in their cheeriest blooms of pink and white. You might see an old garden shed topped with tin, shabby walls worn with old wood peeking through faded layers of paint. There is a romantic charm to such a scene, and I often find myself wishing for a way to bottle up the beauty to enjoy through winter. This collection represents that gathering of spring elements, a dedication to all flower lovers.

Yardage, Coated Fabrics, Precuts, and Patterns Available in April!

moda FABRICS + SUPPLIES®

 modafabrics.com

© 2020 moda fabrics • all rights reserved

OMBRE FADE

Select three background fabrics to make a subtle colour gradient



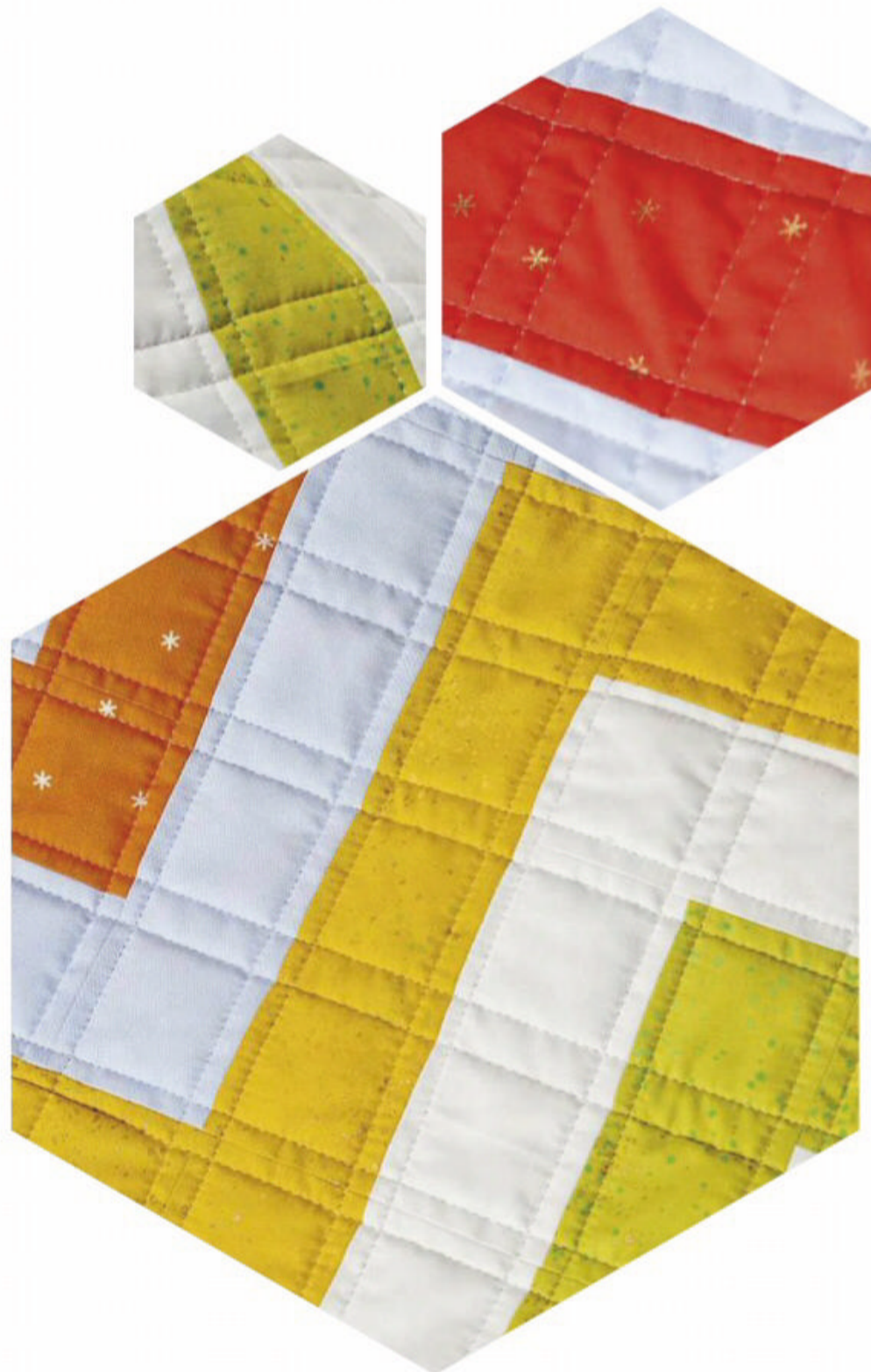

RAINBOW WAVE

Earn your stripes and piece bold basics into graphic blocks that slot together to make a mesmerising effect

BY BOBBIE GENTILI

YOU WILL NEED

- Fabric A (off white background) 1yd
- Fabric B (light blue background) 1yd
- Fabric C (mid blue background) 1yd
- Fabric D (teal) ¼yd
- Fabric E (bright blue) ⅜yd
- Fabric F (green) ⅜yd
- Fabric G (yellow) ¼yd
- Fabric H (orange) ⅜yd
- Fabric I (red) ⅜yd
- Fabric J (red grid) ¼yd
- Fabric K (fuchsia) ⅜yd
- Fabric L (purple) ⅜yd
- Fabric M (pink) ¼yd
- Binding fabric: ½yd
- Backing fabric: 3¾yds
- Batting: 65in x 76in

FINISHED SIZE

- 57in x 68in



NOTES

- Seam allowances are ¼in throughout.
- Press seam allowances open, unless otherwise instructed.
- Bobbie used the Stripology Squared ruler from Creative Grids for cutting.
- RST = right sides together.
- WOF = width of fabric.
- Fabric supplied by Ruby Star Society (rubystarsociety.com)

FABRICS USED

- Solid fabrics are Bella Solids in Off White, Light Blue and Glacier by Moda.
- Print fabrics are from the Speckled, Spark, Grid, Brushed and Social collections by Ruby Star Society.

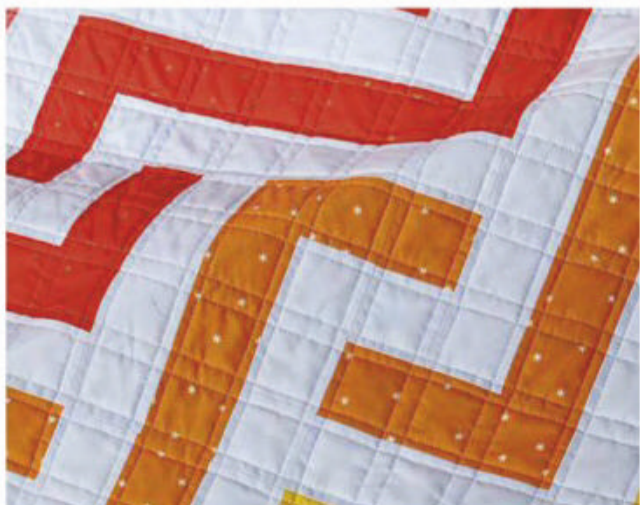

PICK AN EYE-CATCHING BACKING FABRIC THAT HAS AS MUCH IMPACT AS THE FRONT!

CUTTING OUT

- 1 From Fabric A cut:
 - One 2¾in x WOF.
 - Twelve (12) 2½in x WOF. Subcut three (3) of the strips into six (6) 8½in x 2½in, five (5) 6½in x 2½in and five (5) 2½in squares. Reserve the remaining partial strip for strip sets later.

- 2 From Fabrics B and C cut:
 - Twelve (12) 2½in x WOF. Subcut three (3) of the strips into six (6) 8½in x 2½in, five (5) 6½in x 2½in and five (5) 2½in squares. Reserve the remaining partial strip for strip sets.

- 3 From Fabric D cut:
 - Three (3) 2½in x WOF. Subcut one (1) strip into four (4) 9in x 2½in. Subcut one (1) strip into two (2) 9in x 2½in and reserve the remaining strip.

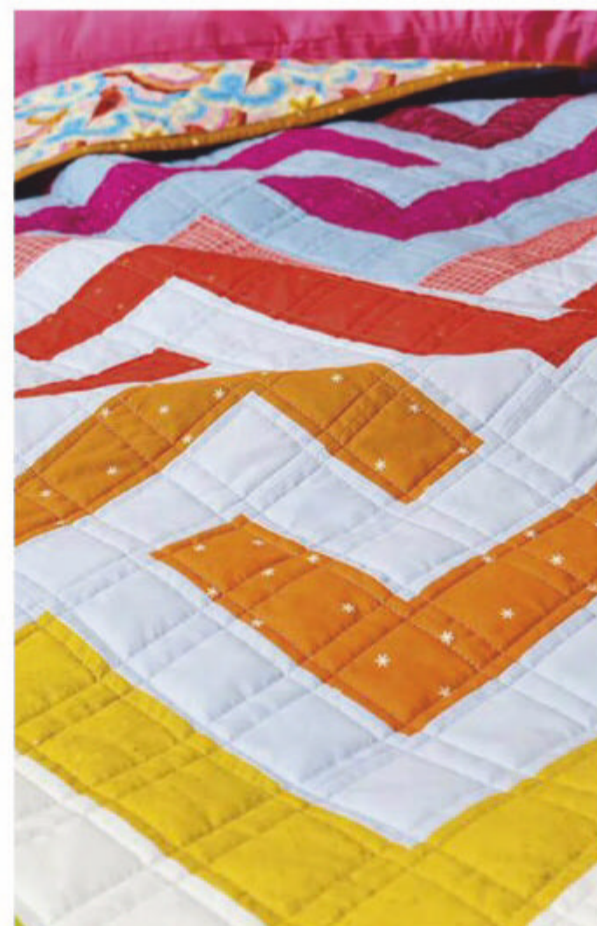

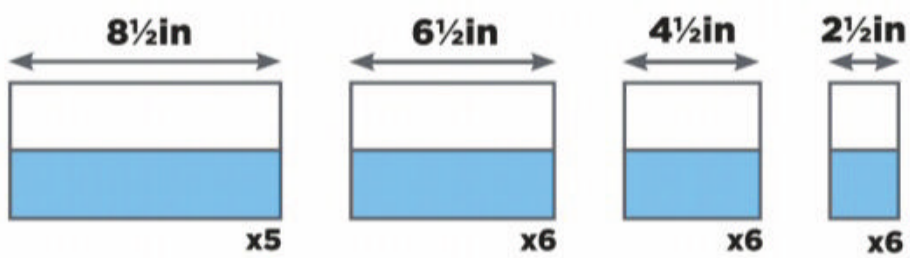

Fig 1

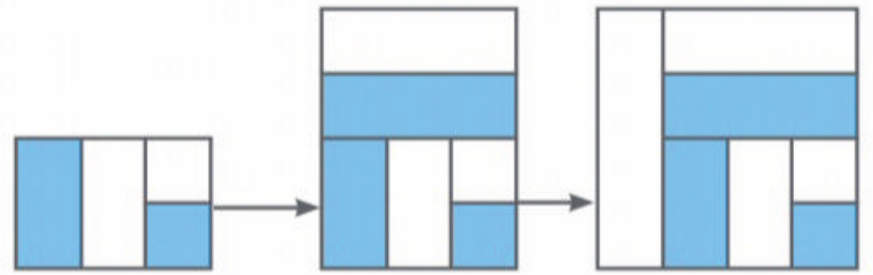

Fig 2

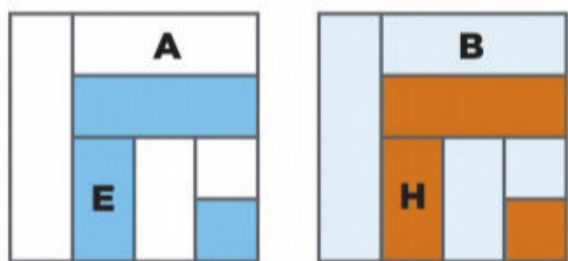

Fig 3

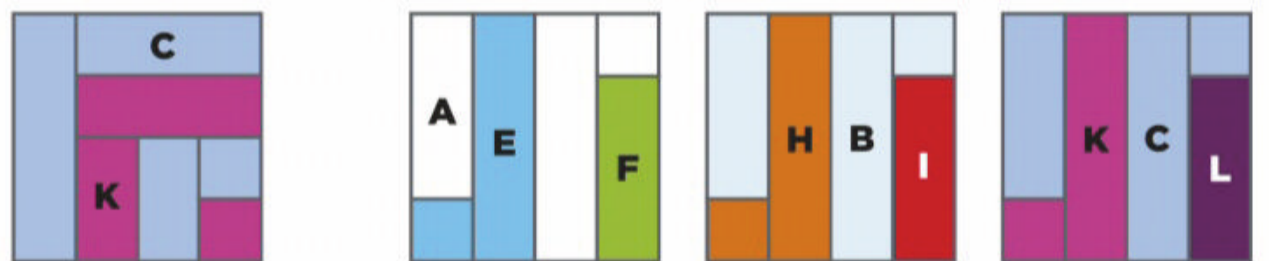

Fig 4

4 From each of Fabrics E, H and K cut:
 ■ Four (4) 2 1/2 in x WOF. Subcut one (1) strip into five (5) 2 1/2 in squares. Reserve the remaining partial strip for strip sets later.

5 From each of Fabrics G, J and M cut:
 ■ Three (3) 2 1/2 in x WOF. Subcut one (1) strip into four (4) 8 1/2 in x 2 1/2 in. Subcut one (1) strip into one (1) 8 1/2 in x 2 1/2 in and five (5) 2 1/2 in squares and reserve the remaining partial strip.

6 From each of Fabrics F, I and L cut:
 ■ Four (4) 2 1/2 in x WOF. Subcut one (1) strip into five (5) 6 1/2 in x 2 1/2 in and reserve the remaining partial strips.

7 From the binding fabric cut:
 ■ Seven (7) 2 1/2 in x WOF.

PIECING QUARTER LOG CABIN BLOCKS

8 Sew a partial 2 1/2 in x WOF Fabric A and partial 2 1/2 in x WOF Fabric E strip together along the long edges to make a partial double strip set. Repeat with three full 2 1/2 in x WOF Fabric A and Fabric E strips to make three full double strip sets. Subcut the strip sets to yield:

- Five 8 1/2 in x 4 1/2 in 2-stripe units (set aside).
- Six 6 1/2 in x 4 1/2 in 2-stripe units.
- Six 4 1/2 in square 2-stripe units.
- Six 2 1/2 in x 4 1/2 in 2-stripe units (Fig 1).

9 Sew a 2 1/2 in A/E unit to the A side of a 4 1/2 in A/E unit. Add a 6 1/2 in A/E unit, along the E side, to the long top edge of the unit. Then add an 8 1/2 in x 2 1/2 in Fabric A rectangle to the left side of each unit and

press to complete an 8 1/2 in square Quarter Log Cabin block (Fig 2).

10 Repeat steps 8–9 to make a total of six Quarter Log Cabin blocks each using Fabrics A/E, B/H and C/K (Fig 3).

PIECING S BLOCKS

11 Join a 6 1/2 in x 2 1/2 in Fabric A rectangle to a 2 1/2 in Fabric E square along the short ends. Repeat with a 6 1/2 in x 2 1/2 in Fabric F rectangle and a 2 1/2 in Fabric A square. Make five of each strip.

12 Sew one of each unit from step 11 to opposite sides of the 8 1/2 in A/E unit from step 8, as shown, to complete an 8 1/2 in square S Block (Fig 4).

13 Repeat steps 11–12 to make a total of five S Blocks each using Fabrics A/E/F, B/H/I and C/K/L.

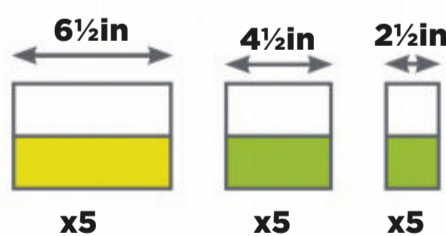

Fig 5

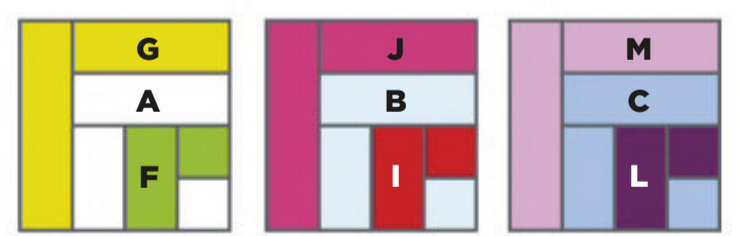

Fig 6

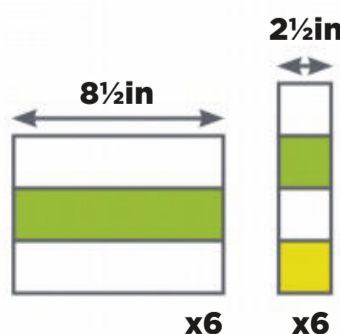

Fig 7

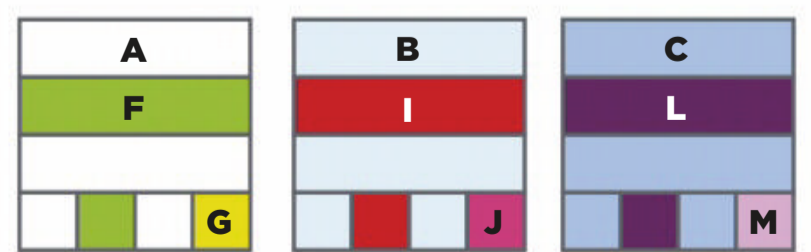

Fig 8



PIECING MIXED QUARTER LOG CABIN BLOCKS

14 Sew a Fabric A $2\frac{1}{2}$ in x WOF and a Fabric F $2\frac{1}{2}$ in x WOF strip together along the long edges to make a double strip set. Subcut the strip set to yield five $4\frac{1}{2}$ in 2-stripe units and five $2\frac{1}{2}$ in 2-stripe units. Sew a Fabric A and G $2\frac{1}{2}$ in x WOF strip and subcut into five $6\frac{1}{2}$ in 2-stripe units (Fig 5).

15 Sew one of each unit and a Fabric G $2\frac{1}{2}$ in x $8\frac{1}{2}$ in rectangle as you did in step 9, to complete an $8\frac{1}{2}$ in square Mixed Quarter Log Cabin block (Fig 6).

16 Repeat steps 14–15 to make a total of five Mixed Quarter Log Cabin blocks each, using Fabrics A/F/G, B/I/J and C/L/M.

PIECING WEAVE BLOCKS

17 Sew two Fabric A $2\frac{1}{2}$ in x WOF strips to either side of a Fabric F $2\frac{1}{2}$ in x WOF strip along the long edges to make a triple strip set. Repeat to make a second triple A/F/A strip set. Subcut the strip sets to yield a total of six $8\frac{1}{2}$ in x $6\frac{1}{2}$ in 3-stripe units. Sew a partial Fabric G strip to the remainder of the triple strip set. Subcut into six $2\frac{1}{2}$ in 4-strip units (Fig 7).

18 Sew a $2\frac{1}{2}$ in 4-stripe unit, with the Fabric G square at the bottom right, to one long edge of an A/F/A 3-stripe unit as shown to complete an $8\frac{1}{2}$ in square weave block (Fig 8).

19 Repeat steps 17–18 to complete a total of six weave blocks each, using Fabrics A/F/G, B/I/J and C/L/M.

PIECING SETTING TRIANGLE BLOCKS

20 Sew a Fabric A $2\frac{3}{4}$ in x WOF strip to the remaining partial Fabric D $2\frac{1}{2}$ in x WOF strip along the long edges to make a double strip set. Subcut the strip set to yield six 5in wide 2-stripe units.

21 Join pairs of A/D 2-stripe units along the Fabric A edge to make three units with white centres. Join a 9in x $2\frac{1}{2}$ in Fabric

D strip to either side of each block. Subcut each block diagonally to yield five setting triangles. You will have one extra triangle. Trim the corners, so the side edges of each triangle are $8\frac{1}{2}$ in long (Fig 9).

ASSEMBLING THE QUILT TOP

22 Arrange and join the blocks into diagonal rows (Fig 10). Then join the rows. Pay careful attention to the block layout and orientation as you piece, and match seams carefully.

23 Square off the left, right and top edges of the quilt top by aligning the $\frac{1}{4}$ in line of your ruler with the points before trimming (Fig 11). Baste $\frac{1}{8}$ in from the edge to keep seams secured and stop stretching. Alternately, save the trimming until after quilting is complete.

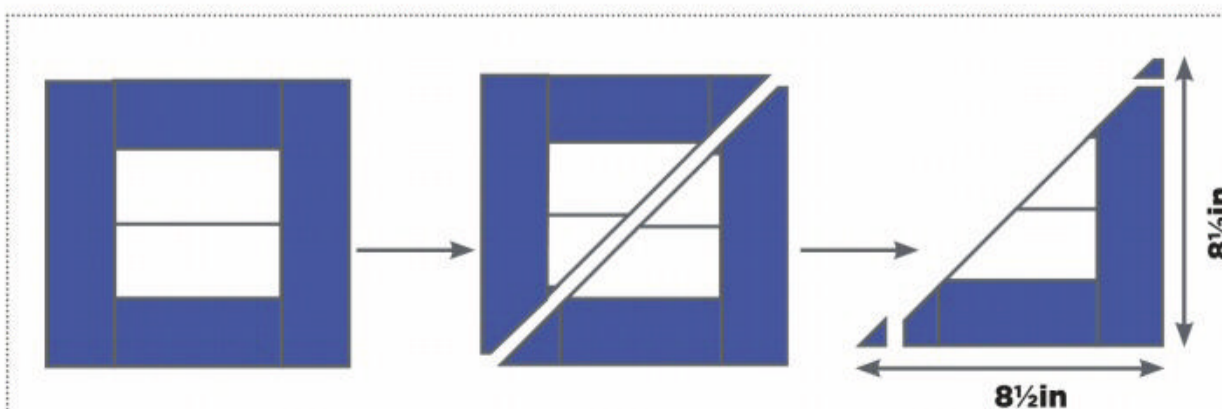

Fig 9



QUILTING AND FINISHING

24 Cut the backing fabric in half across the width. Remove the selvages and sew the two pieces together using a 1/2in seam. Press the seam open.

25 Press the quilt top and backing well. Make a quilt sandwich by placing the backing fabric right side down, the batting on top, then place the quilt top centrally and right side up. Baste the layers together using your preferred method.

26 Quilt as desired. Bobbie quilted a diagonal double cross-hatch using light grey thread. Trim off the excess batting and backing fabric and square up the quilt.

27 Sew the binding strips together end-to-end using diagonal seams. Press the seams open and trim away the dog ears. Fold in half lengthways, wrong sides together, and press.

28 Sew the binding to the right side of the quilt, creating a neat mitre at each corner. Fold the binding over to the back of the quilt and hand stitch in place to finish.

Carefully pin your pieces before sewing to ensure that all of your strips match up perfectly



Fig 10



Fig 11

YOU WILL NEED

To make cushion one:

- Assorted bright print scraps: ¼yd total or three (3) 2½in x WOF strips
- Assorted neutral solid scraps: ¼yd total or three (3) 2½in x WOF strips
- Lining fabric (optional): ⅝yd
- Batting: 20in square
- Backing fabric: ⅔yd
- Binding fabric: ¼yd or scraps

FINISHED SIZE

- 16in square



CUTTING OUT

1 From the print fabrics cut:

- Four (4) 2½in x 12½in.
- Eight (8) 2½in x 6in.
- Eight (8) 2½in x 2in.

2 From the solid fabrics cut:

- Eight (8) 2½in x 8in.
- Eight (8) 2½in x 4in.

3 From the lining fabric cut:

- One (1) 20in square.

4 From the cushion back fabric cut:

- One (1) 33in x 11in.

5 From the binding fabric cut:

- Two 2½in x WOF or piece from scraps.



GOT SCRAPS LEFT OVER FROM PIECING THE QUILT? WHIP UP A CUSHION OR TWO!

PIECING TRIANGLE STRIP UNITS

6 Arrange one 8in rectangle, one 6in rectangle, one 4in rectangle and one 2in rectangle from bottom to top, alternating solids and prints and aligning left edges. Join at the long edges (Fig 1).

7 Trim at a 45-degree angle, across the points, as shown. Then measure 7½in from the point and trim off the pieced side to make a left triangle unit (Fig 2).

8 Repeat steps 6–7 to make six left triangle units.

9 Repeat steps 6–7 again but align the right edges instead to make and trim two right triangle units as shown (Fig 3).

PIECING CORNER BLOCKS

10 Fold a left triangle unit, a right triangle unit and one 2½in x 12½in print rectangle in half along the long edges and

mark the centre point. Join one triangle strip unit to each long edge of the print rectangle, lining up the marked centre points (Fig 4). Trim to 8½in square. Repeat to make two corner blocks.

PIECING PARALLEL BLOCKS

11 Repeat step 10 using two left triangle units with one 2½in x 12½in

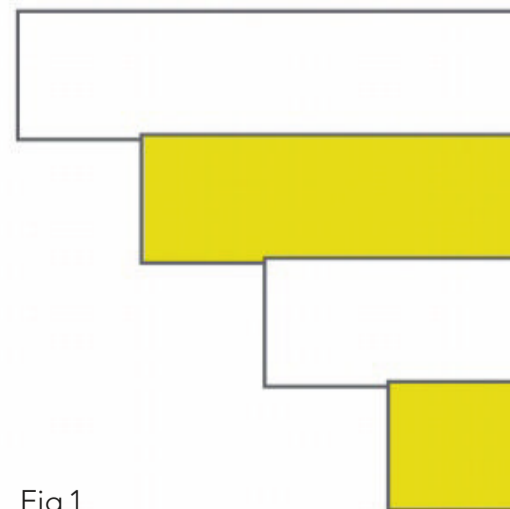

Fig 1

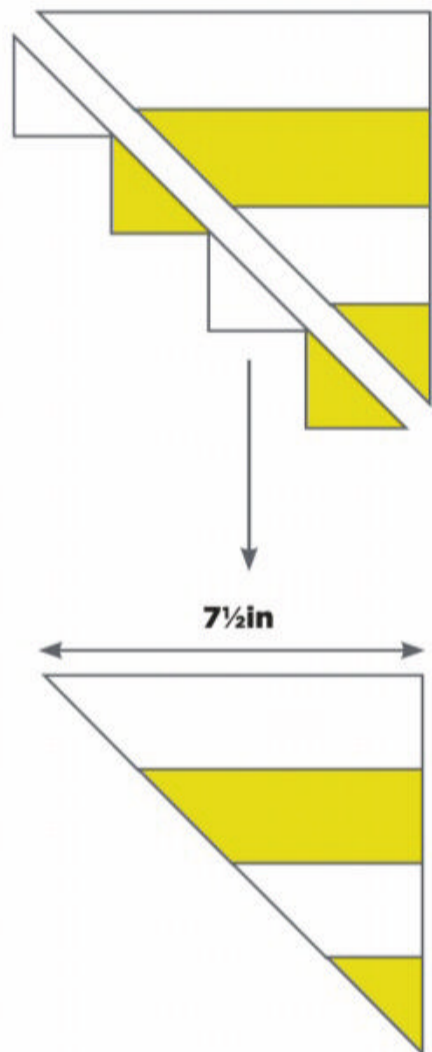

Fig 2

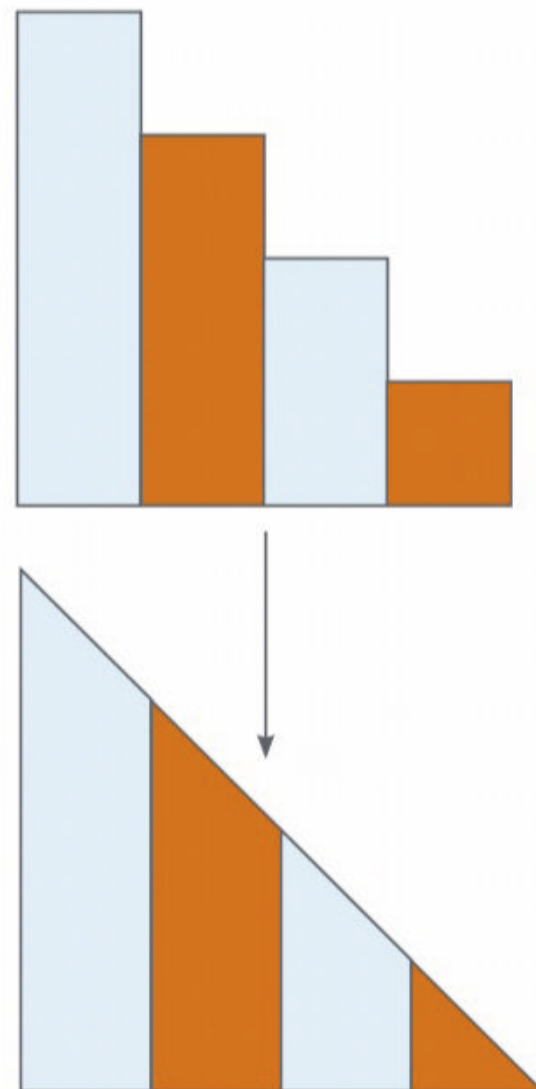

Fig 3

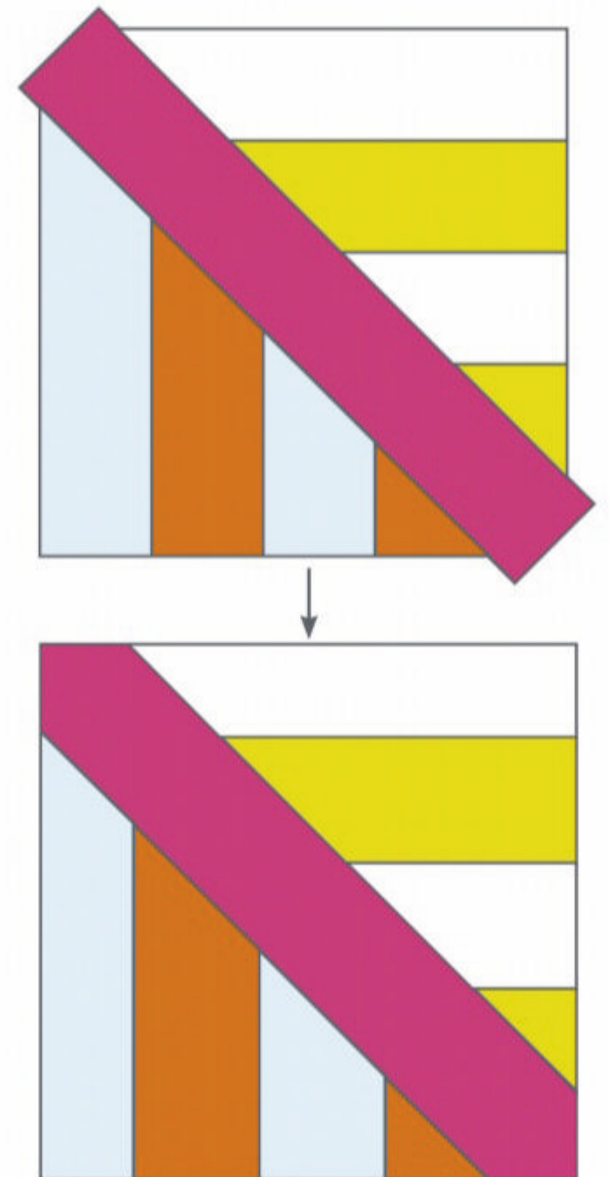

Fig 4



print rectangle to make two parallel blocks (Fig 5).

ASSEMBLING THE CUSHION FRONT

12 Arrange the two corner blocks and two parallel blocks with their long centre strips forming an X, referring to the Layout Diagram for placement. Experiment with the placement of the blocks until you find a layout that you like, balancing colours and prints.

QUILTING AND FINISHING

13 Press the quilt top and backing well. Make a quilt sandwich by placing the

lining fabric right side down, the batting on top, then place the cushion front centrally and right side up. Baste the layers together using your preferred method.

14 Quilt as desired. Bobbie has quilted straight lines $\frac{3}{4}$ in apart, echoing the X shape. Trim off the excess batting and backing fabric and square up the quilt.

15 Take the 33in x 11in cushion back fabric rectangle. On one long edge, turn over a $\frac{1}{2}$ in seam to the wrong side, then turn over another $\frac{1}{2}$ in and press. Topstitch to secure. Cut in half to make two 16 $\frac{1}{2}$ in x 10in cushion backs.

16 Layer the front and back wrong sides together with the hem edges of the two back pieces overlapping for an envelope closure. Pin together and sew around the four edges with a scant $\frac{1}{4}$ in seam allowance. Sew the binding strips RST along the short ends with diagonal seams. Press open. Fold the binding in half along the length WST and press. Sew the binding to the cushion front, folding a neat mitre in each of the corners. Then hand stitch the binding to the back of the cushion to finish.

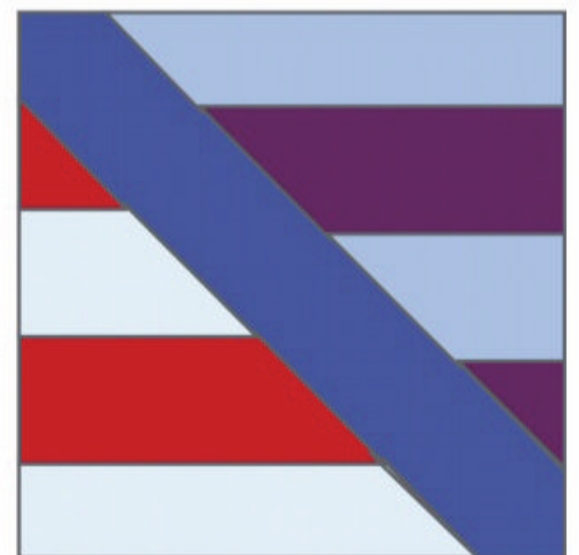
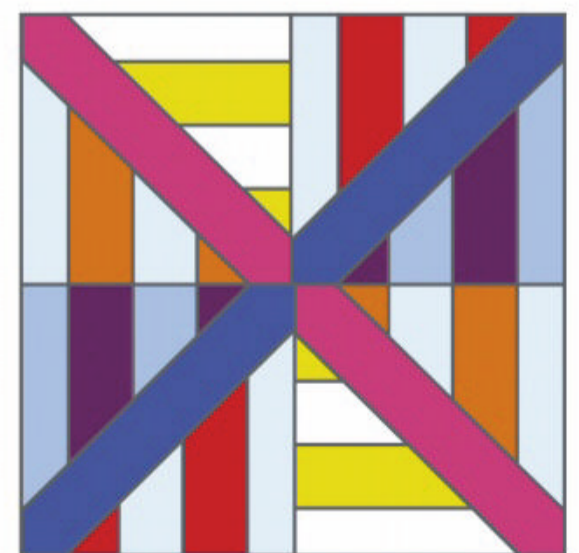

Fig 5



Layout Diagram

YOU WILL NEED

To make cushion two:

- Assorted bright print scraps: ¼yd total or three (3) 2½in x WOF strips in total
- Assorted neutral solid scraps: ¼yd total or three (3) 2½in x WOF strips in total
- Lining fabric (optional): ⅝yd
- Batting: 20in square
- Backing fabric: ⅔yd
- Binding fabric: ¼yd or scraps

FINISHED SIZE

- 16in square



CUTTING OUT

1 From the print fabrics cut:

- Four (4) 2½in x 12½in.
- Eight (8) 2½in x 6in.
- Eight (8) 2½in x 2in.

2 From the solid fabrics cut:

- Eight (8) 2½in x 8in.
- Eight (8) 2½in x 4in.

3 From the lining fabric cut:

- One (1) 20in square.

USE YOUR SMALLEST REMNANTS TO MAKE A SCRAPPY BINDING TO TOP THE CUSHION OFF



4 From the cushion back fabric cut:
■ One (1) 33in x 11in.

5 From the binding fabric cut:
■ Two 2½in x WOF or piece from scraps.

PIECING THE CUSHION FRONT

6 Repeat steps 6–10 of the previous cushion instructions to make a total of four corner blocks. Arrange the blocks with their long centre strips forming a square on point and strips forming a pinwheel in the centre, referring to the Layout Diagram for placement. Experiment with the placement of the blocks until you find a layout that you like, balancing colours and prints.

QUILTING AND FINISHING

7 Repeat steps 13–16 of the previous cushion instructions to complete the cushion.

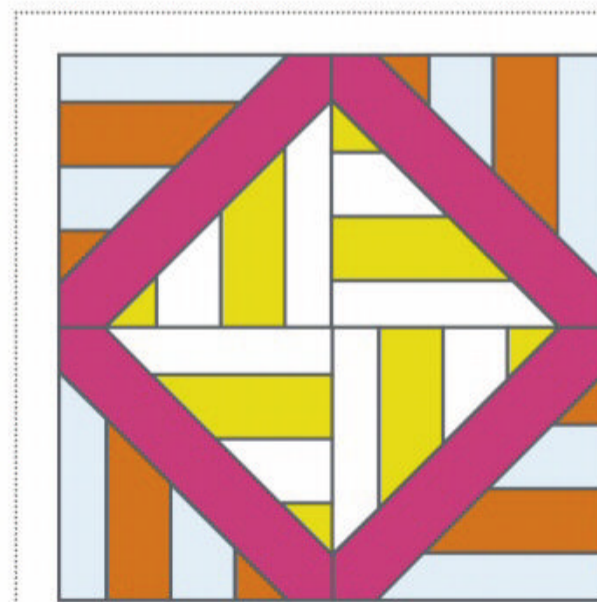

Layout Diagram



Bobbie Gentili

Bobbie's lifelong creativity and love of mathematics has led to an obsession with making and designing quilts
geekybobb.com
[geekybobb](https://www.instagram.com/geekybobb)

"I love working on a BERNINA - it's like an extension of my hands."

TIFFANY PRATT, DESIGNER

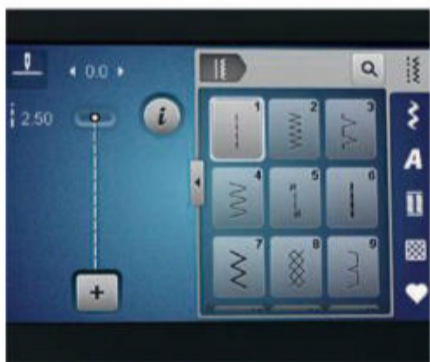

- EASY-TO-USE 4.3" COLOUR TOUCH SCREEN
- JUMBO BOBBIN WITH 70% MORE THREAD
- ADJUSTABLE PRESSER FOOT PRESSURE
- AUTOMATIC THREAD CUTTER
- BERNINA STITCH REGULATOR (BSR) COMPATIBLE ¹
- 40 BUILT-IN QUILTING STITCHES



¹ BSR functionality requires the optional BSR accessory foot

The B 475 QE is the perfect size for small spaces. But don't let its size fool you. Its powerful enough to handle the thick layers of even your biggest quilts. Consistent thread tension means every stitch is impeccable. Plus extras, like the thread cutter, keep projects moving towards completion. Time and time again, the consistent quality of BERNINA rises to your highest quilting standards.

To find out more about the new BERNINA 4 Series, call 020 7549 7849, visit www.bernina.co.uk or email info@bernina.co.uk

* conditions apply. 7 Year warranty valid on machines purchased between 1/8/2013 and 31/12/2020 from an authorised BERNINA UK stockist. See www.bernina.co.uk for full details.



made to create

BERNINA

SUBSCRIBE

PATCHWORK & **Quilting**
Sharing your passion for fabric!

START YOUR
FREE TRIAL
TODAY!

SAVE TIME AND HASSLE WITH
AN ANNUAL SUBSCRIPTION!



**GREAT REASONS TO
SUBSCRIBE DIGITALLY!**

- 1** The latest issue is available instantly
- 2** Receive a further 13 issues in your first year
- 3** All issues download automatically
- 4** Download it once... read it offline forever



iPad is a trademark of Apple Inc., registered in the U.S. and other countries.
App Store is a service mark of Apple Inc.

Perfect for your iPad or iPhone!



START YOUR FREE TRIAL TODAY!

The digital version of the magazine does not include the cover gift that you would find on print newsstand copies.



LIGHT & BRIGHT

Contrast against punchy prints with a crisp white background fabric



AIRFLOW

Grab a Jelly Roll and start sewing... this sleek and sophisticated strip-pieced quilt can be ready in a weekend!

BY SUSAN STANDEN

YOU WILL NEED

- Print fabrics (includes binding) 2⁵/₈yd total or one (1) Jelly Roll
- White fabric: 2³/₈yd total or one (1) Jelly Roll
- Backing fabric: 3¹/₂yds
- Batting: 62in x 80in
- One (1) copy of the Triangle template

FINISHED SIZE

- 54in x 72in

NOTES

- Seam allowances are 1/4in, unless otherwise noted.
- Press seams to one side, unless otherwise instructed.
- Jelly Rolls are a set of 2 1/2in x 42in strips. For this project you will need at least thirty seven (37) print strips and thirty three (33) white strips.

FABRICS USED

- Print fabrics are from the Airflow collection by Sasha Ignatiadou for Ruby Star Society.
- White fabric is a Bella Solid in White by Moda.

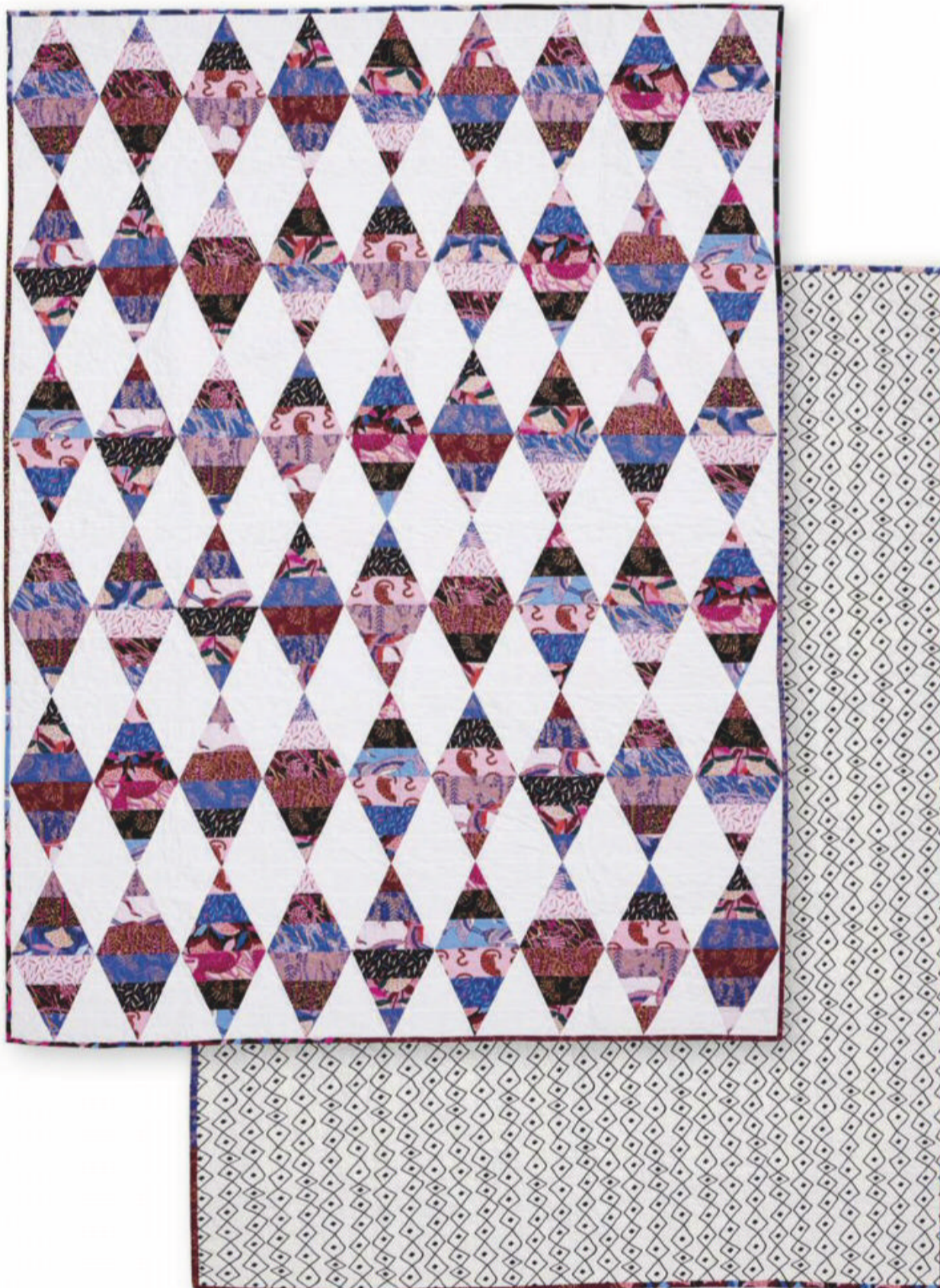

NEVER TRIED STRIP PIECING BEFORE? THIS IS THE PERFECT QUILT TO TRY THE TECHNIQUE

CUTTING OUT

- 1 If you are using precut Jelly Roll strips, skip steps 2–3, as your fabrics are already cut into strips.
- 2 From your print fabrics cut:
 - Thirty seven (37) 2 1/2in x WOF strips.
- 3 From your white fabric cut:
 - Thirty three (33) 2 1/2in x WOF strips.

PIECING THE QUILT TOP

- 4 Take six of your print strips and join along the long edges (Fig A). Fold in half lengthwise, RST, bringing the two long raw edges together. Sew along the long edge to form a tube (Fig B).

5 Press the tube flat, so a seam runs along the top and bottom of the tube. Using the template, cut triangles from the tube, cutting through all layers of fabric.

6 Rotate the template between cuts (Fig C). You should be able to cut a total of eleven triangles from the tube.

7 Carefully unpick the stitches at the top point of each triangle, and open up to form a diamond shape (Fig D).

8 Repeat the process in steps 4–7 to make a total of fifty four diamonds. You will have seven print strips left over to use for the binding.



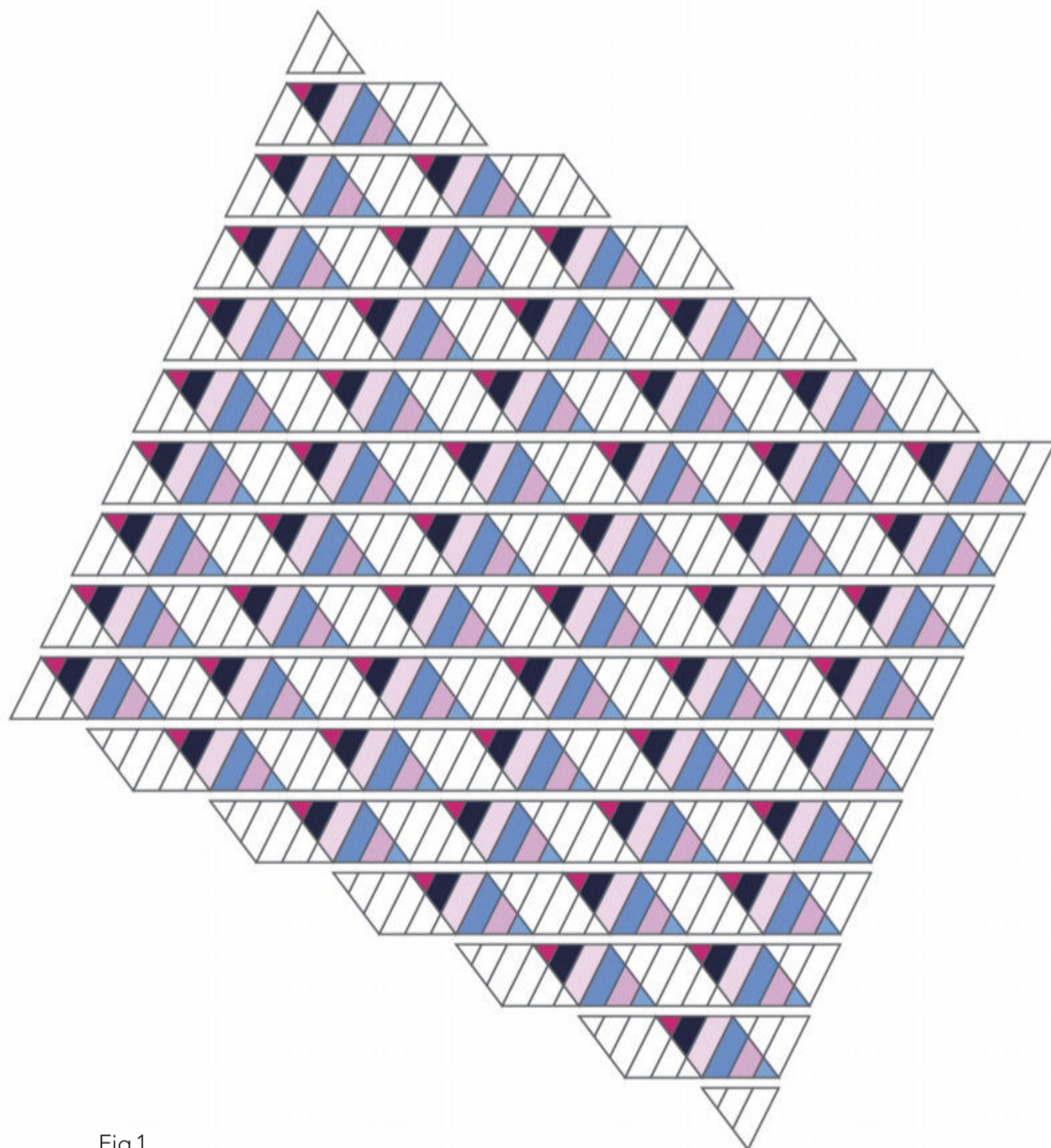

Fig 1

9 Repeat steps 4–7 with your white strips to make a total of fifty five diamonds. You will have three strips left over to use in step 10.

10 Piece the three remaining white strips together along the long edges. Cut a total of ten triangles from this strip set, using the template.

11 Take five of your white diamonds from step 9. Unpick the seam at the centre to form ten triangles.

12 Arrange your diamonds and triangles in diagonal rows. Sew the pieces into rows, carefully matching strip seams (Fig 1). Sew the rows together, matching seams between white and print diamonds to align the points. Trim the sides of the quilt top, leaving a generous $\frac{1}{4}$ in seam allowance from the edge of each print diamond.

QUILTING AND FINISHING

13 Cut the backing fabric in half across the width. Remove the selvages and

sew the two pieces together using a $\frac{1}{2}$ in seam. Press the seam open.

14 Press the quilt top and backing well. Make a quilt sandwich by placing the backing fabric right side down, the batting on top, then place the quilt top centrally and right side up. Baste the three layers together using your preferred method.

15 Quilt as desired. Susan quilted a swirling free-motion design across the quilt using a matching white thread. Trim the excess batting and backing fabric.

16 Sew the binding strips together end-to-end using diagonal seams. Press the seams open and trim the dog ears. Fold in half lengthways, wrong sides together, and press.

17 Sew the binding to the right side of the quilt, creating a neat mitre at each corner. Fold the binding over to the back of the quilt and hand stitch in place around the edge to finish.

PIECING THE QUILT TOP

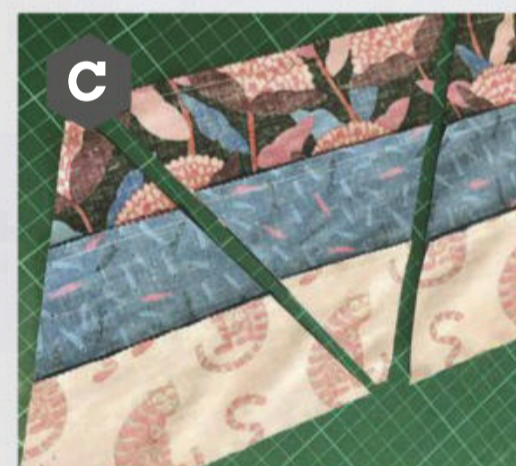
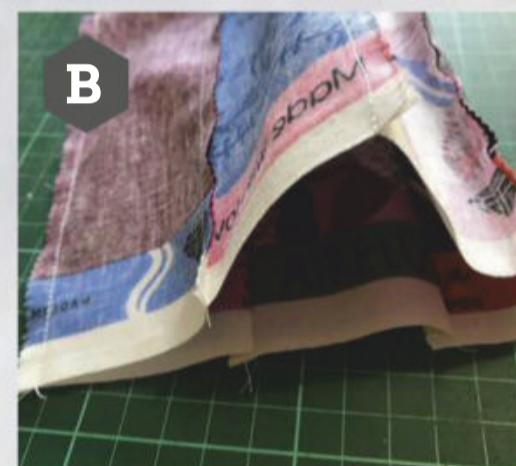
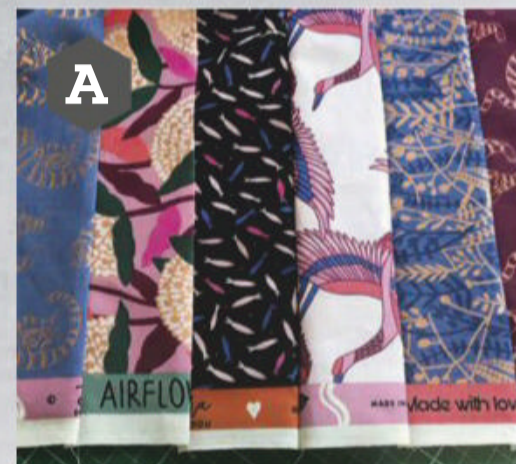

Susan Standen

Susan's bright, bold quilt designs are always bursting with colour and character!

➤ canadianabroad-susan.blogspot.co.uk

📷 [canadianabroad](https://www.instagram.com/canadianabroad)

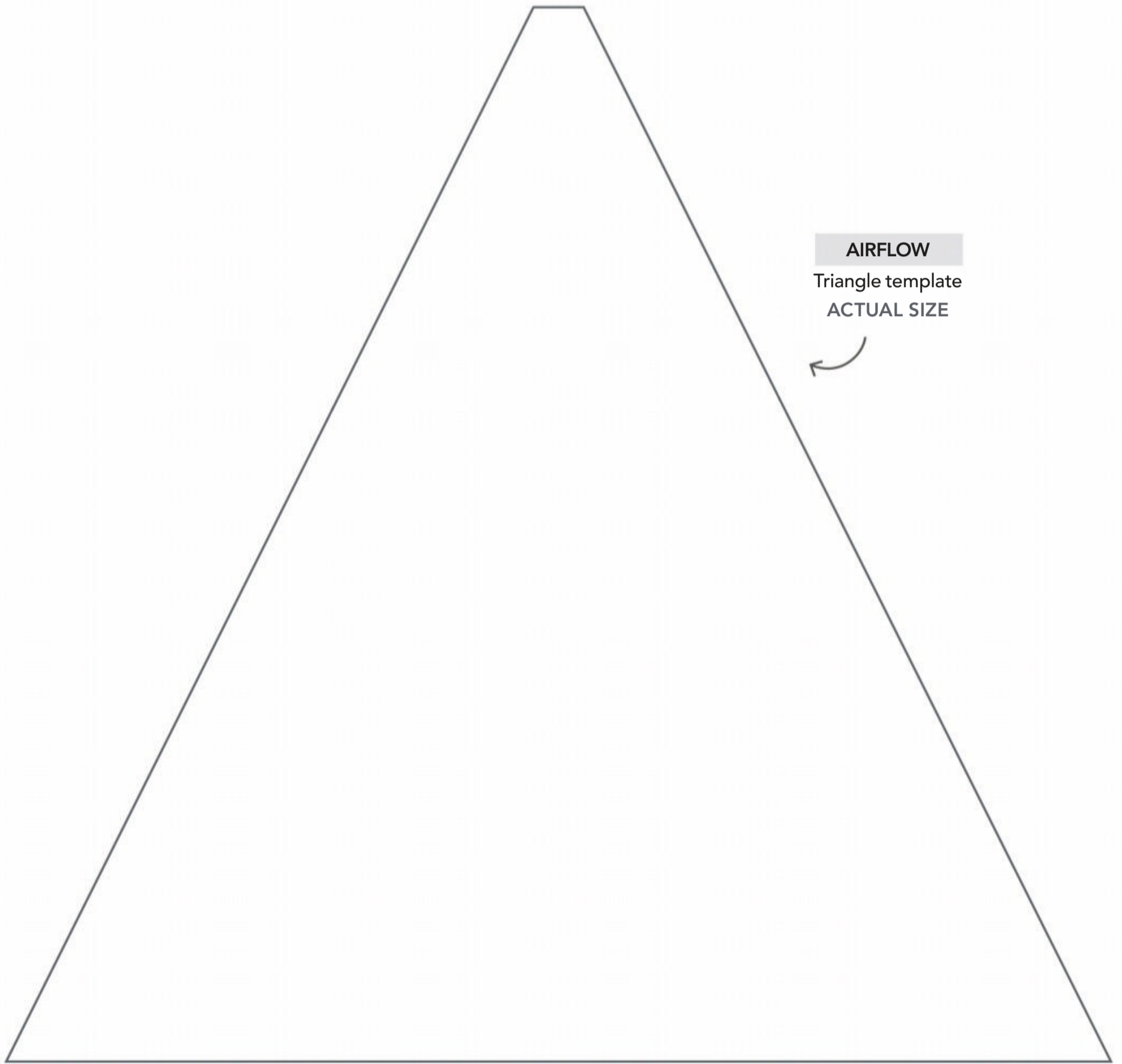

AIRFLOW
Triangle template
ACTUAL SIZE



ELEMENTS



Earth



Air



Fire



Water

Elements by Ghazal Razavi of FIGO features 24 colors in abstract depictions of earth, water, fire and air in subtle, tonal and textural looks. The textures depicting the artwork are not random but carefully drawn out in a mark-making style and aesthetic.

Visit FIGOFabrics.com to view the entire collection and use the Product Finder tool to locate a quilt shop that carries this line.

FIGOFabrics.com
[@FIGOFabrics](https://www.instagram.com/FIGOFabrics)



FIGO
F A B R I C S





Bundle up!

Whether you need a little help or simply love looking at a cheerful collection of fabrics, there are many benefits to working with bundles. **Kate Basti** unravels her reasons

Oh, how I love a good fabric bundle! In fact, one could even say that I'm a collector of fabric bundles, but shhhhh. Don't tell my husband that! My collection of fabric bundles has been growing since before my early quilting days. And yes, you really did read that correctly... I said *before* my early quilting days.

I began hoarding fabrics a full two years before I worked up the nerve to teach myself to sew. I like to think that I was just planning ahead. In truth, I was lacking the confidence that I could teach myself to sew. I hadn't used a sewing

machine since my eighth grade Home Economics class. After seeing a pretty quilt that a blogger made in 2008, I knew that I wanted to learn to sew. And when I stumbled across fabric designed by Anna Maria Horner online I had to have it despite that fact that I didn't even own a sewing machine.

In fact, my very first fabric bundle was Anna Maria Horner's Garden Party line for FreeSpirit Fabrics.

had. The most common are fat eighth and fat quarter bundles, as well as half yard and yardage bundles. There are bundles that are comprised exclusively of one fabric line and those that are curated, either by you or someone else. There are perks to each type, and I'm going to share with you a few reasons as to why I enjoy bundles so much and how I personally put them to use.

There are times when I enjoy the fabric pulling process and there are times I don't. This is when a ready-made fabric bundle saves the day

My parents purchased it for me for Christmas after I'd convinced them it was just about the only thing I wanted under the tree that year. It would be another few years before I'd actually cut into it, but while it waited, that bundle was a wonderful source of inspiration for me and later a catalyst for my sewing career. As I'm sure you are aware, there are many, many types of bundles to be

I Skip the work There are times when I enjoy the fabric pulling process and there are times I don't. Sometimes I'm simply too eager to start a project to take the time to make decisions about colours, prints and blenders. This is when a ready-made bundle saves the day. Just untie the ribbon and start cutting! Bundles made of a single fabric line often have a theme and colour palette, thereby removing any and all guesswork of coordinating fabrics.

There are also many local retailers and online fabric shops that curate their own bundles. I often find beautiful bundles of varying lines and colour palettes that I likely would never have come up with myself. I have great admiration for those who have a keen eye for curating wonderfully gorgeous bundles of fabric. Their bundles often boost my creativity and are a real treat to purchase.

Sometimes a full fabric collection calls out to be used together in one quilt – they're perfectly curated!

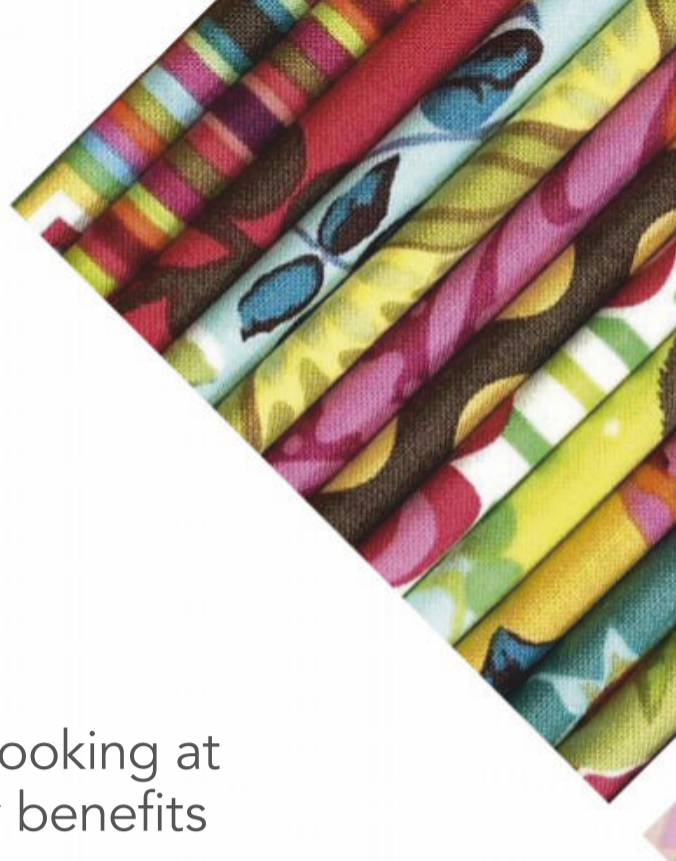



Many quilt patterns are designed to be pre-cut friendly... perfect for sewing with bundles!

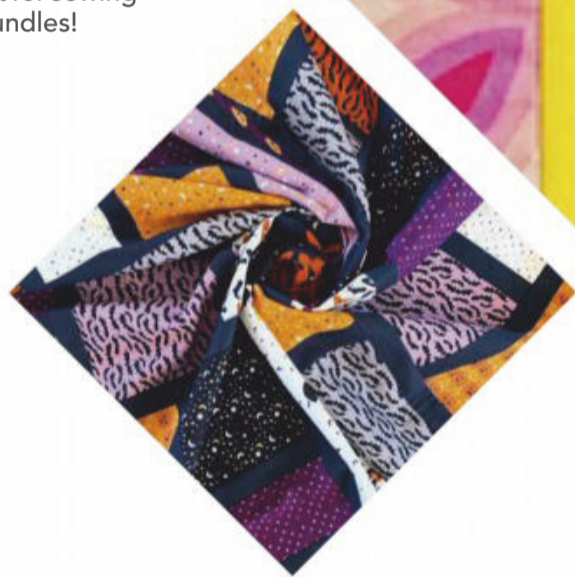

2 Get a sample When viewing or ordering fabric online, it can be difficult to tell if the colours and sizes of prints are exactly what I want, so I'll often purchase a fat eighth bundle and use it as a sample. This allows me to see each print of the fabric line in person before I make the decision of whether I want a larger bundle or even yardage of particular prints. And regardless, I can always put the fat eighth bundle to use.

3 Bundle-friendly patterns There are many fat quarter-friendly quilt patterns out there. Apps like

Pinterest make finding them quite easy, as does a simple Google search. And there are loads of books dedicated to bundle-friendly projects. Don't want to spend the money for an entire book when all you want is one pattern? Check with your library to see if they have it!

4 Do it yourself Now you're a pro in the fabric curation game, try pulling your own bundle! Start by choosing a colour palette and take fabrics from your stash (or add fabrics to your online shopping cart) that match those particular colours. Another method, and my own personal favourite, is

to pull what I call a 'hero' print. This is a print from which you can build the rest of your fabric bundle around. Pull smaller prints and blenders with coordinating colours that play nicely with your chosen hero print until you have a selection that makes your heart happy. It's a fail-safe way to make a quilt that you'll truly love.

Put a few of these ideas and tips to use, and you'll have your very own bundle collection before you know it. Happy sewing!

👉 quiltwithkate.com
 📷 [katebasti](https://www.instagram.com/katebasti)



ON REPEAT
Get into a rhythm and chain piece your HSTs for a speedy finish!

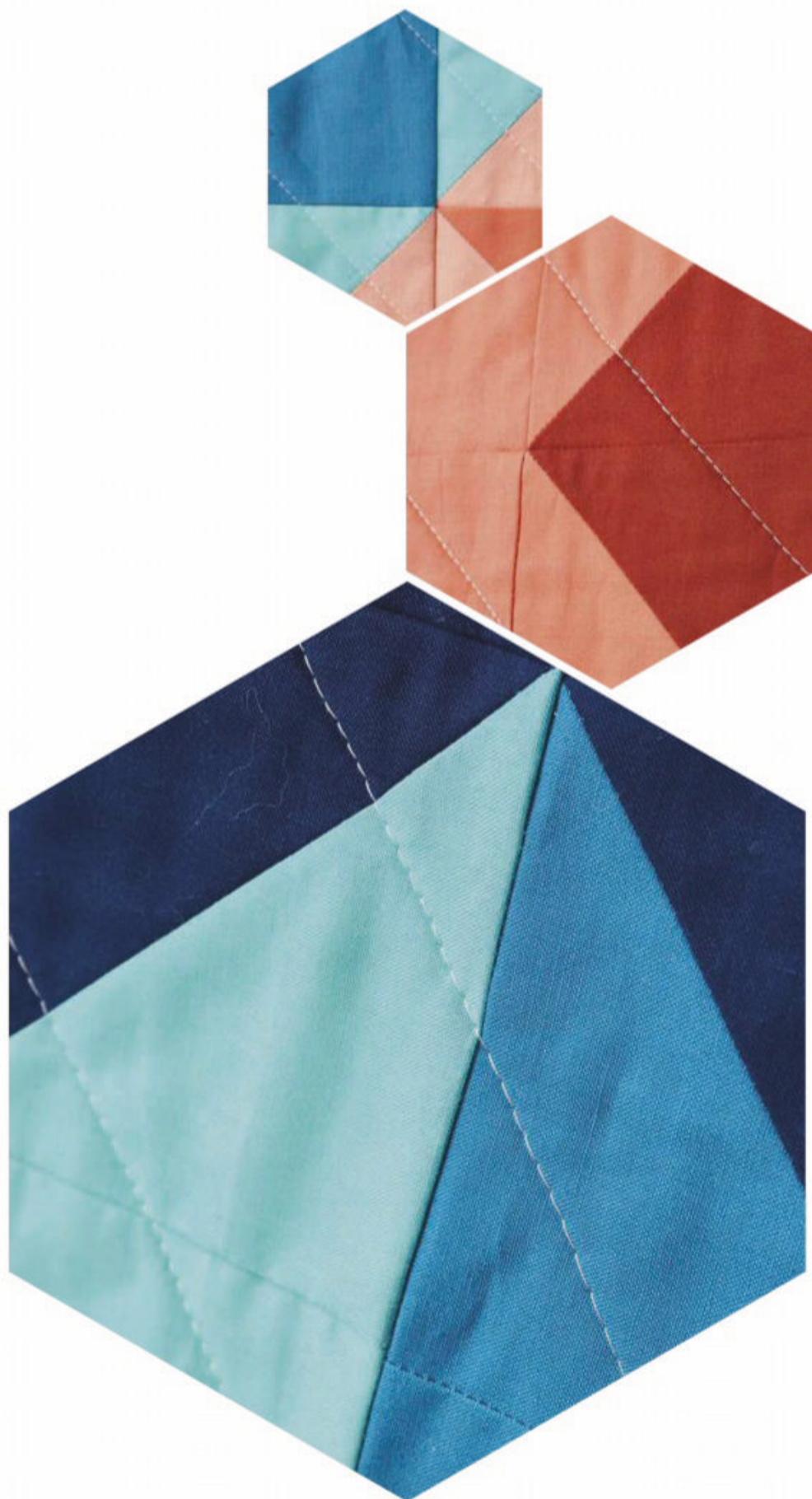

MODERN MOSAIC

Embrace your colour crush and whip up
a Half-square Triangle-based quilt with
an irresistible tonal finish

BY AMANDA MCCABE

YOU WILL NEED

- Fabric A (pale pink) ⁵/₈yd
- Fabric B (light coral) ³/₈yd
- Fabric C (mid coral) ⁵/₈yd
- Fabric D (rust) fat quarter
- Fabric E (aqua) ³/₈yd
- Fabric F (teal) ¹/₂yd
- Fabric G (dark blue) ⁵/₈yd
- Binding fabric: ¹/₂yd
- Batting: 56¹/₂in square
- Backing fabric: 3¹/₄yds

FINISHED SIZE

- 48¹/₂in square

NOTES

- Seam allowances are ¹/₄in throughout, unless otherwise noted.
- Press seams open throughout, unless otherwise instructed.
- RST = right sides together.
- WOF = width of fabric.
- HST = Half-square Triangle.
- Fabrics supplied by Robert Kaufman (robertkaufman.com)

FABRICS USED

- Solids are Kona Cotton Solids by Robert Kaufman in Pearl Pink, Creamsicle, Nectarine, Paprika, Pool, Caribbean and Storm.
- Backing fabric is from the Chelsea collection by Stephanie Ryan for Robert Kaufman.



USE SIMPLE DIAGONAL LINES OF QUILTING TO LET YOUR GRAPHIC PIECING SHINE

CUTTING OUT

- 1 From Fabric A cut:
 - Two (2) 10in x WOF. Subcut into six (6) 10in squares.
- 2 From Fabric B cut:
 - Four (4) 10in squares.
- 3 From Fabric C cut:
 - Two (2) 10in x WOF. Subcut into eight (8) 10in squares.
- 4 From Fabric D cut:
 - Two (2) 10in squares.
- 5 From Fabric E cut:
 - Four (4) 10in squares.
- 6 From Fabric F cut:
 - One (1) 10in x WOF. Subcut into four (4) 10in squares.
 - One (1) 4¹/₂in x WOF. Subcut into eight (8) 4¹/₂in squares.
- 7 From Fabric G cut:
 - Two (2) 10in x WOF. Subcut into six (6) 10in squares.

- 8 From the binding fabric cut:
 - Six (6) 2¹/₂in x WOF.

8-IN-1 HSTS

9 Place a 10in Fabric A square and a 10in Fabric C square RST. Draw two diagonal lines making an "X" on the wrong side of the square. Sew ¹/₄in either side of the drawn lines. Cut the square in half vertically and horizontally. Then cut on the drawn lines to yield eight HSTs. Press. Trim each unit to 4¹/₂in square (Fig 1).

- 10 Repeat step 9, using the 10in squares to make HSTs in the following combinations:
 - Fabric A/C HSTs: forty.
 - Fabric A/G HSTs: eight.
 - Fabric B/C HSTs: eight.
 - Fabric B/E HSTs: sixteen.
 - Fabric B/G HSTs: eight.
 - Fabric C/D HSTs: sixteen.
 - Fabric E/F HSTs eight.
 - Fabric E/G HSTs: eight.
 - Fabric F/G HSTs: twenty four.



BLOCK CONSTRUCTION

11 Referring to Fig 2 for placement, arrange HSTs and Fabric F squares in six rows of six. Sew together in rows. Alternate pressing seams to the left and right by row so the rows nest when sewn together. Sew the rows together and press seams open to complete the block. Repeat to make a total of four 24½in square blocks (Fig 2).

PIECING THE QUILT TOP

12 Referring to Fig 3 for placement, arrange the quilt top in two rows of two blocks. Note the blocks will mirror one another. Sew the top row together and press. Sew the bottom row together and press. Sew the rows together and press to complete the top.

QUILTING AND FINISHING

13 Cut the backing fabric in half across the width. Remove the selvages and sew the two pieces together using a ½in seam. Press the seam open.

14 Press the quilt top and backing well. Make a quilt sandwich by placing the backing fabric right side down, the batting on top, then place the quilt top centrally and right side up. Baste the layers together using your preferred method.

15 Quilt as desired. Amanda quilted diagonal lines approx 2in apart. Trim off the excess batting and backing fabric and square up the quilt.

16 Sew the binding strips together end-to-end using diagonal seams. Press the seams open. Fold in half lengthways, wrong sides together, and press.

17 Sew the binding to the right side of the quilt, creating a neat mitre at each corner. Fold the binding over to the back of the quilt and hand stitch in place to finish.

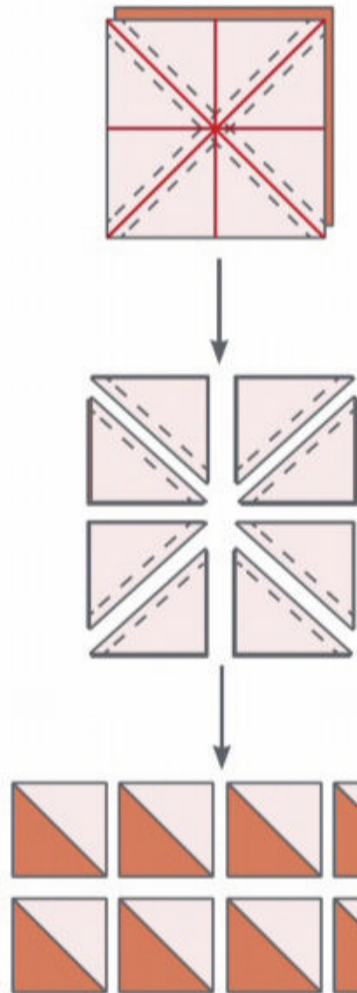

Fig 1

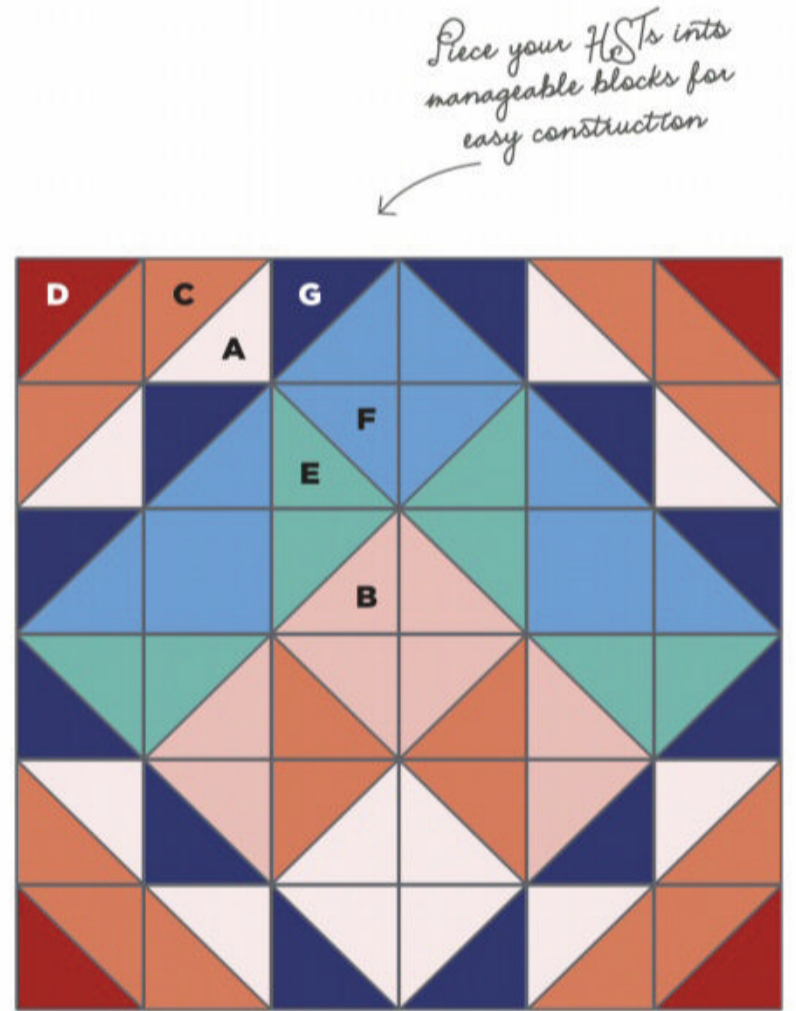

Fig 2

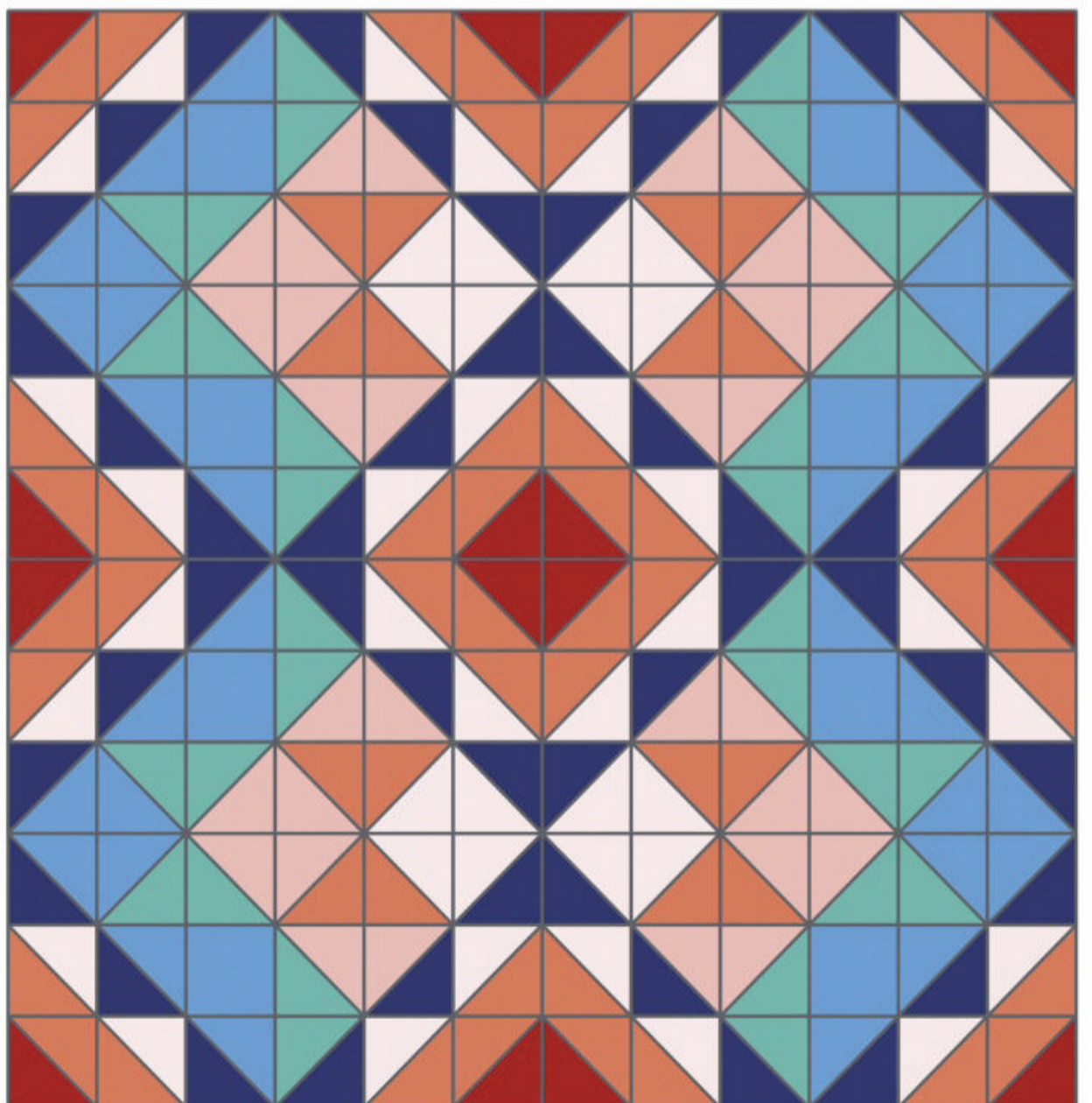

Fig 3



COMPLEMENT THE COLOURS IN THE PATCHWORK WITH A PRINT BACKING FABRIC

YOU WILL NEED

To make the cushion:

- Fabric A (pale pink) fat eighth or 1/8yd
- Fabric B (light coral) fat eighth or 1/8yd
- Fabric C (mid coral) fat eighth or 1/8yd
- Fabric D (rust) fat eighth or 1/8yd
- Fabric E (aqua) fat eighth or 1/8yd
- Fabric F (teal) fat eighth or 1/8yd
- Fabric G (dark blue) fat eighth or 1/8yd
- Lining fabric: 5/8yd
- Backing: 5/8yd
- Batting: 22in square
- Cushion insert: 18in square

FINISHED SIZE

- 18in square

CUTTING OUT

- 1 From Fabric A cut:
 - Six (6) 4in squares.
- 2 From Fabric B cut:
 - Four (4) 4in squares.
- 3 From Fabric C cut:
 - Eight (8) 4in squares.
- 4 From Fabric D cut:
 - Two (2) 4in squares.
- 5 From Fabric E cut:
 - Four (4) 4in squares.
- 6 From Fabric F cut:
 - Four (4) 4in squares.
 - Two (2) 3½in squares.
- 7 From Fabric G cut:
 - Six (6) 4in squares.
- 8 From the lining fabric cut:
 - One (1) 22in square.
- 9 From the backing fabric cut:
 - Two (2) 18½in x 13in.

PIECING THE CUSHION FRONT

10 Place one Fabric A square and one Fabric C square RST. Draw a diagonal line from corner to corner on the wrong side of one square. Sew ¼in on either side of the drawn line. Cut along the drawn line to yield two HSTs. Press. Trim each to 3½in square.

11 Repeat step 10 to make HSTs in the following colour combinations:

- Fabric A/C HSTs: ten.
- Fabric A/G HSTs: two.
- Fabric B/C HSTs: two.
- Fabric B/E HSTs: four.
- Fabric B/G HSTs: two.
- Fabric C/D HSTs: four.
- Fabric E/F HSTs two.
- Fabric E/G HSTs: two.
- Fabric F/G HSTs: six.

12 Referring to the Cushion Layout Diagram for placement, arrange HSTs and Fabric F squares in six rows of six. Sew together in rows. Alternate pressing seams to the left and right by row so the rows nest when sewn together. Sew the rows together, pressing seams open to complete the cushion top.

QUILTING AND FINISHING

13 Make a quilt sandwich by placing the lining square right side down, then the batting, then centring the cushion top block facing right side up. Baste and quilt as desired. Trim away excess batting and backing fabric.

14 Take one 18½in x 13in backing fabric piece and place right side down. Fold the longest side over by ½in and press.

Fold the ½in section in half again and press. Hem, securing the fold in place. Repeat for the second backing piece.

15 Place the quilted cushion top right side up. Layer the envelope pieces right sides down over the cushion top with the raw edges lining up around the perimeter of the cushion and the hemmed edges running through the middle. Note that the two backing pieces are intended to overlap. Pin in place.

16 Sew all the way around the edge using a ¼in seam allowance. Snip the corners and turn right side out, then insert a cushion pad to finish.

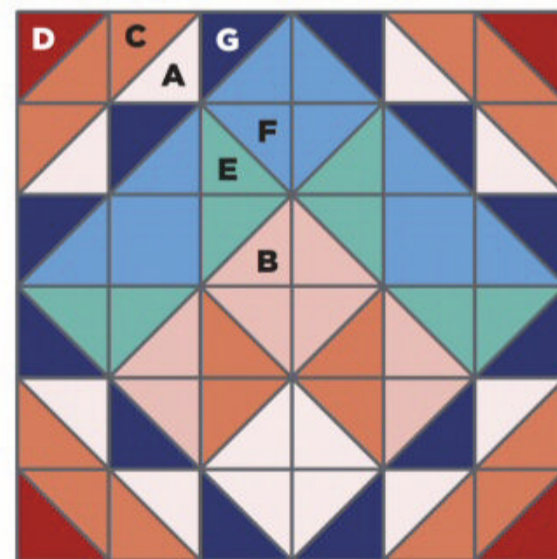

Layout Diagram



Amanda McCabe

Amanda is a woodworker and modern quilter who loves playing with bold lines and bright colour palettes

✉ jamesandgracie.com

📷 [jamesandgraciehandmade](https://www.instagram.com/jamesandgraciehandmade)

The *Grace*
Company
Fine Quilting Products



www.jbsewing.com

J & B Sewing Machine Co LTD are the
UK sole distributors of The Grace Company products



Curlew Close, Queensway Meadows, Newport, NP19 4SY

01633 281555

THANK YOU



To donate to the NHS please go to: nhscharitiestogether.co.uk



Bikini Sous La Pluie

Best In Show

Celebrate dogs and dog lovers with Best In Show! This cute canine fabric collection was inspired by designer Caroline's collection of ceramic dogs, as well as vintage illustration and midcentury style. This collection is begging to be used on DIY pet projects – just imagine a handmade dog collar, water dish mat, or pet bed sewn with these prints!

AVAILABLE NOW!

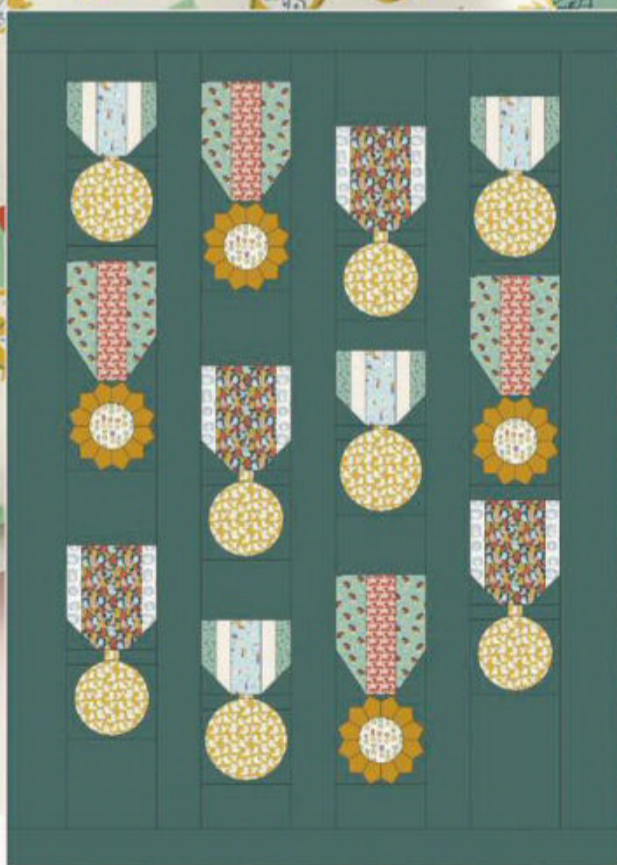

Gold Medals · Free Quilt Pattern · 63" x 87"
Designed by Tessa Rae Williams

Paintbrush Studio Fabrics™ are available at local, independent quilt shops and select online retailers.

For purchasing information, visit pbsfabrics.com/collections/best-in-show-by-bikini-sous-la-pluie





SILLY SAUSAGE

Make the most of your print fabric scraps to bring a ditsy duo of canine softies to life!

BY LUCY WARD

YOU WILL NEED

Makes one (1) dog:

- Floral fabric: ½yd
- Solid fabric: 7in x 9in
- Mix of five (5) spot, solid or stripe fabric scraps: each at least 4in square
- Black fleece fabric: 3½in x 2½in
- Polyester toy stuffing
- Blue and black wool felt scraps
- One (1) copy of the Ear, Stripe, Eyelid, Eye, Nose, Head Gusset, Back Side Body and Front Side Body Sausage Dog templates

FINISHED SIZE

- 21in x 8in



NOTES

- Seam allowances are ¼in, unless otherwise noted.
- RST = right sides together.
- RS = right side.
- When cutting two of a template piece, cut on a folded layer of fabric to make one regular and one mirror image piece.
- Templates include seam allowances where necessary.
- Mark positions and openings on the reverse of the fabrics using a pencil.
- Clip notches into the curves and corners for a smooth finish.
- Instructions are based on the blue dog.

FABRICS USED

Blue floral fabric is Bouquet Blue and pink floral is Trellis Pink, both from the Mae Flowers collection by Penny Rose.



CREATE DIFFERENT CHARACTERS FOR EACH POOCH THROUGH YOUR CHOICE OF FABRICS!

CUTTING OUT

- 1 From the floral fabric cut:
 - Two (2) pieces using the Front Side Body template.
 - Two (2) pieces using the Back Side Body template.
 - Two (2) pieces using the Ear template.
 - One (1) piece using the Head Gusset template.
- 2 From the solid fabric cut:
 - Two (2) pieces using the Ear template.
- 3 From each of the patchwork fabrics, use the Stripe template to cut:
 - Two (2) rectangles (ten (10) in total).
- 4 From the black fleece cut:
 - One (1) piece using the Nose template.
- 5 From the pale blue wool felt cut:
 - Two (2) pieces using the Eyelid template.
- 6 From the black wool felt cut:
 - Two (2) pieces using the Eye template.

MAKING THE DOG

- 7 Pin and sew a floral and solid ear piece RST, leaving the short ends open. Clip notches in the curves on the seam allowances before turning the ear RS out. Repeat for the other ear and press them both flat.
- 8 Lay the head gusset piece on top of one front side body piece, RST, matching A and B points. Sandwich one ear between them, where marked, with its RS facing towards you. Pin the head gusset along the top edge of the head between A and B. Take time to manipulate the fabrics until they lie smoothly together. Baste first, which will also help to create a smooth shape for sewing (Fig A). Sew in place with the gusset piece on top and be sure not to bunch the fabric underneath the seam. Remove the basting stitches, trim the seams and clip small notches into the curves, taking care not to snip the seam.
- 9 Pin the remaining front side body piece to the other side of the head gusset, RST, sandwiching the other ear between, as before (Fig B). Baste, making sure the



ears are aligned, then sew and finish the seam as in step 8.

10 Lay out five body rectangles, alternating the solid and print fabrics as shown. Pin and sew the pieces RST, along the long edges (Fig C). Press the seams open. Repeat with the remaining body rectangles.

11 Pin the pieced body to the short end of the matching front and back side body pieces. Pin and carefully sew the pieces RST (Fig D). Press.

12 Lay the two body sides RST and begin pinning at point B on the head. Make sure to align the patched stripes on either side of the body. Work around the body and legs and back up to meet the seam of the head gusset at point A. Tuck the ears out of the way of the stitching. Baste first if you prefer, then sew, leaving an opening on the hind leg.

MAKING THE DOG

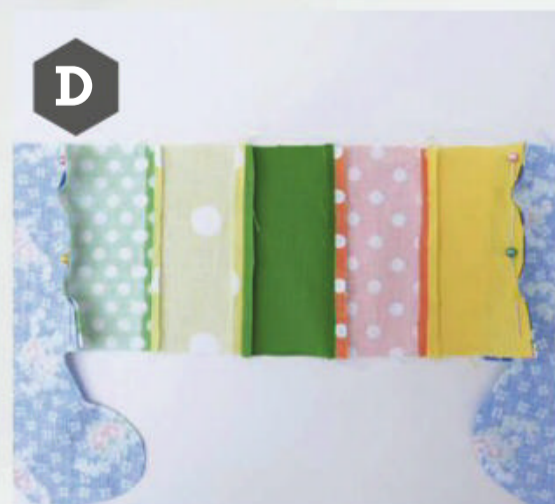



13 Trim the seam allowances and clip notches into the corners of the seam allowances, particularly around the legs. Turn the dog RS out, pushing out the legs and head using your fingers, along with a wooden stick or paintbrush end. Press first and then begin to stuff the dog, firmly but carefully, taking care not to burst the seams. Begin at the nose and head and gradually fill up the legs and then the body and tail. Push lots of stuffing in, so

the dog is really nice and firm. Once stuffed, ladder stitch or overstretch the opening closed.

MAKING THE FACE

14 Wrap and pin the fleece nose triangle over the end of the dog's muzzle, blunt tip out. Overstitch in black all along the tip of the stuffed nose (Fig E). Once you have sewn all the way around, continue sewing up the centre to draw the open sides together, up to the tip of the triangle. Then fold the flap of fabric over onto itself, lining the end up with the edge of the nose base. Sew this securely with overstitches, then finally sew up each side of the nose to finish it off (Fig F).

15 Refer to the photos as a guide to position and pin the eye pieces on both sides of the head. Make sure they are level with one another by viewing from all sides. Lightly mark the position using a pencil or chalk marker. Sew on the black felt eyes first, using tiny overstitches in black thread (Fig G). Then lay the blue eyelid piece halfway over the top of the eye. Pin in place and overstretch in coordinating thread along the upper edge only (Fig H). Leave the straight bottom edge of the eyelid unsewn.

MAKING THE FACE

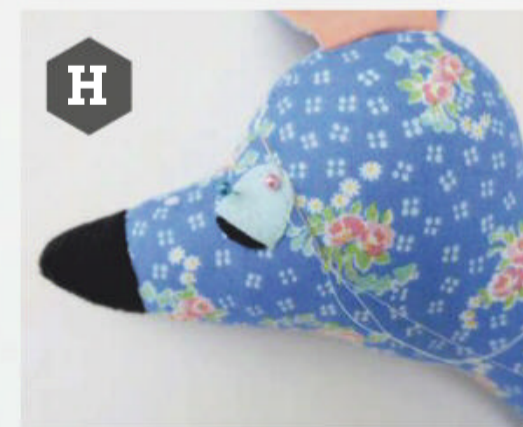

Lucy Ward

When she's not sewing, you can find plushie master Lucy collecting nostalgic items and chilling with her cat!

➤ thewhistlingcowgirl.co.uk
 📷 [thewhistlingcowgirl](https://www.instagram.com/thewhistlingcowgirl)

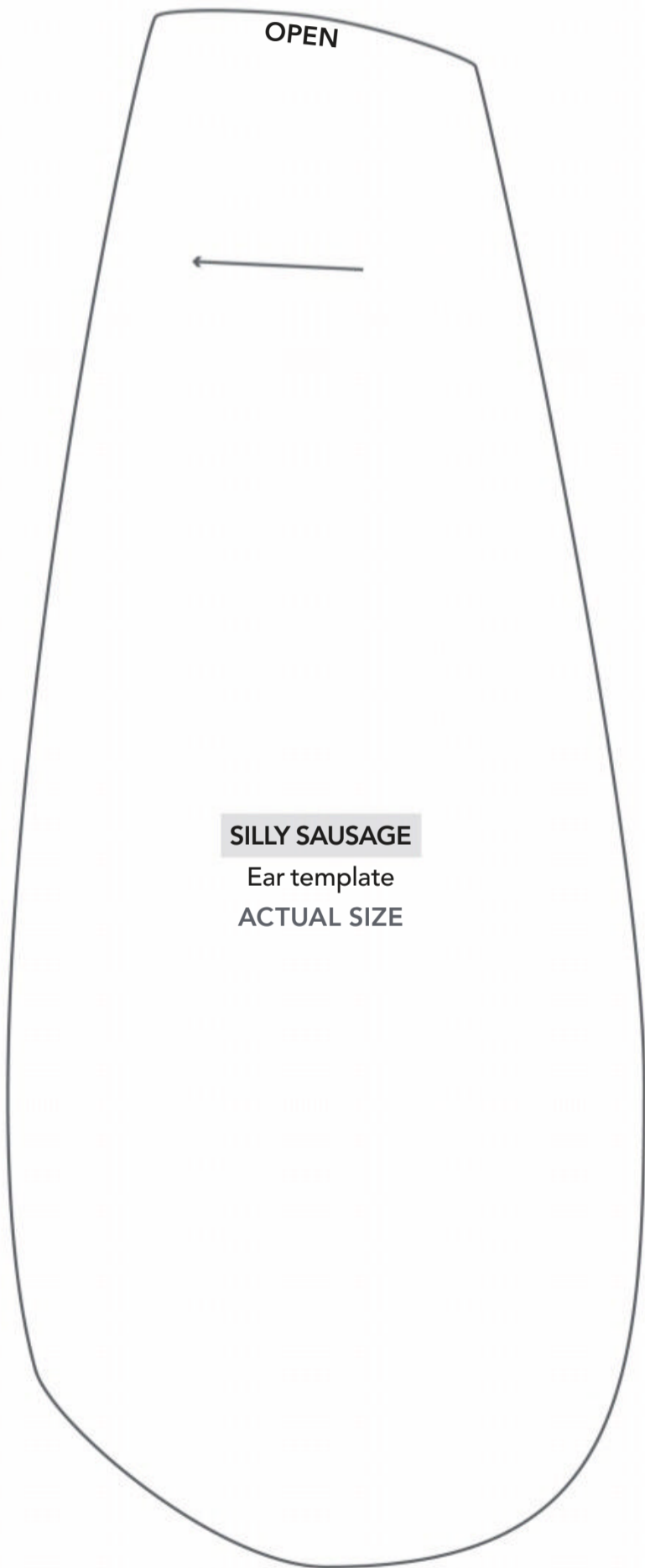

SILLY SAUSAGE
Ear template
ACTUAL SIZE



SILLY SAUSAGE
Stripe template
ACTUAL SIZE

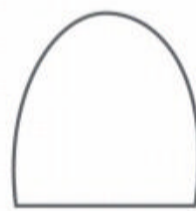

SILLY SAUSAGE
Eyelid template
ACTUAL SIZE

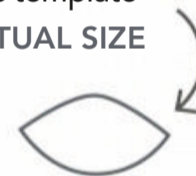

SILLY SAUSAGE
Eye template
ACTUAL SIZE

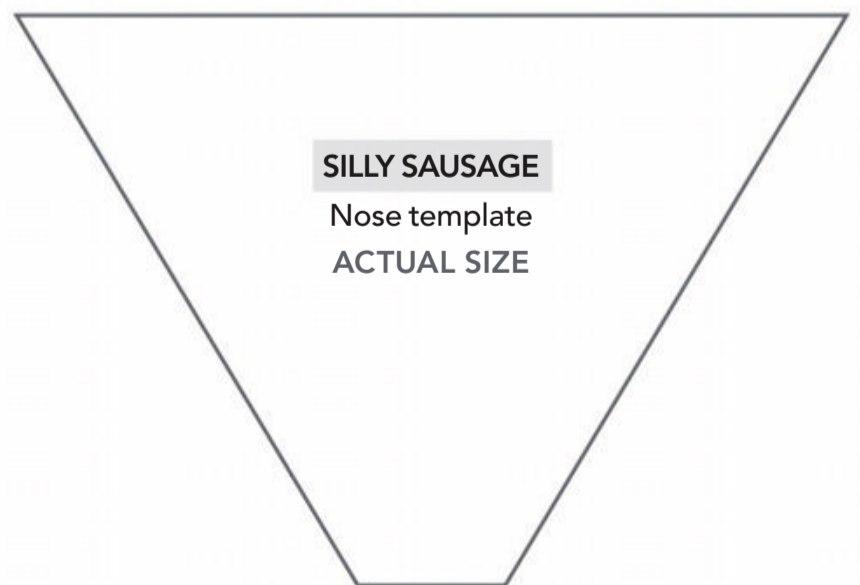

SILLY SAUSAGE
Nose template
ACTUAL SIZE





SILLY SAUSAGE
Head Gusset template
ACTUAL SIZE

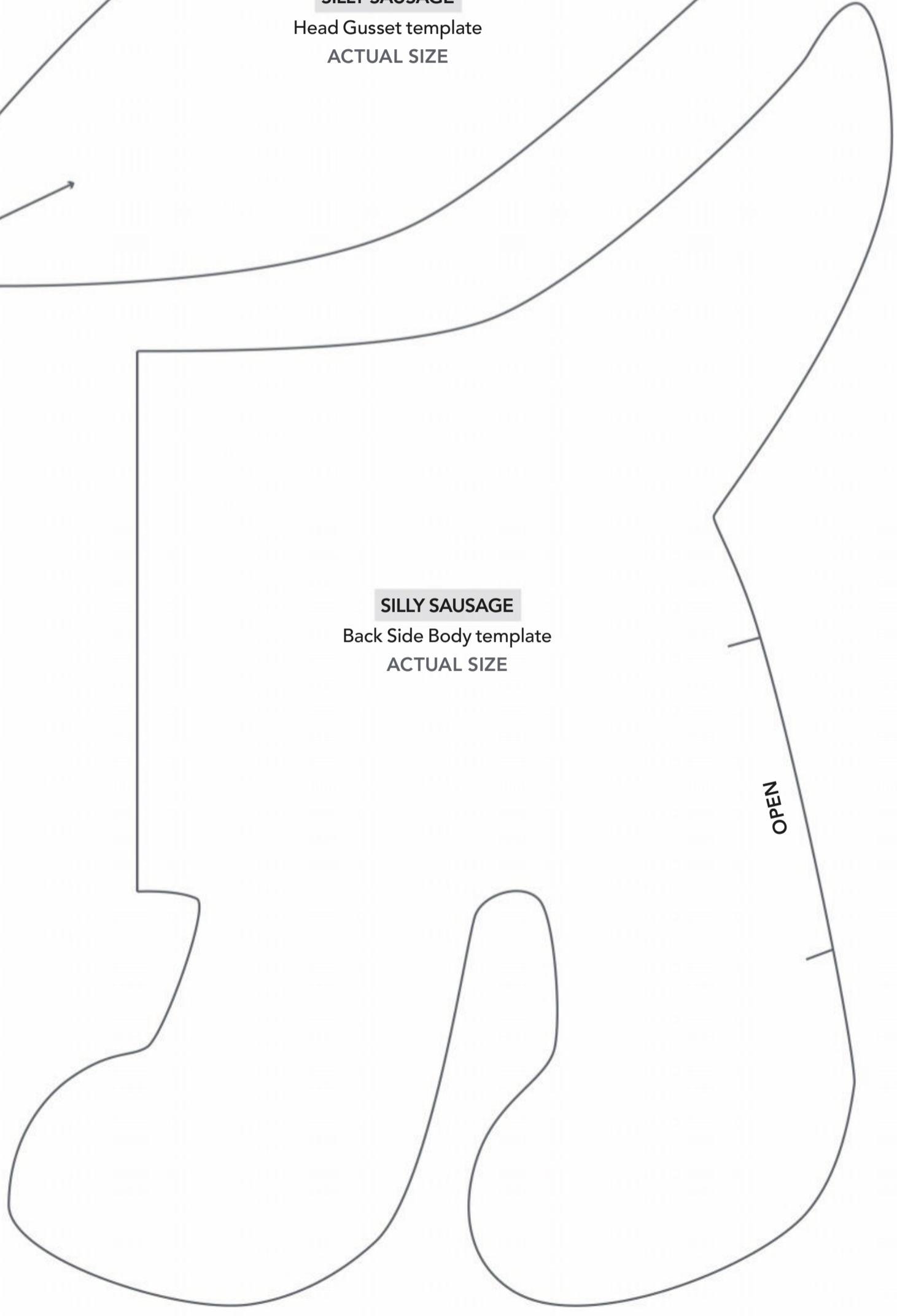

SILLY SAUSAGE
Back Side Body template
ACTUAL SIZE



SILLY SAUSAGE
Front Side Body template
ACTUAL SIZE

CITRUS TWIST

Contrast against the
angular piecing with curvy
Orange Peel quilting





ALL THAT GLITTERS

Mix metallic fabrics with punchy piecing
in a Bear Paw pattern that makes the most
of your pre-cut prints

BY LOU ORTH

YOU WILL NEED

- Background fabric: 3¾yds
- Print fabrics: one (1) Layer Cake or at least thirty two (32) 10in squares
- Backing fabric: 4yds
- Batting: 70in square

FINISHED SIZE

- 62in square

NOTES

- Seam allowances are ¼in, unless otherwise noted.
- Press seams to one side, unless otherwise instructed.
- RST = right sides together.
- WOF = width of fabric.
- Press all fabrics well before cutting.
- If using a directional print fabric, you may wish to lay out pieces for each block before assembling, so that the directional print will be oriented as desired in each corner unit.
- Lou used squares from two Layer Cakes to achieve a greater variety of prints.
- Fabrics supplied by Ruby Star Society (rubystarsociety.com) and Moda (modafabrics.com)
- Batting is Vlieseline Cotton mix 80/20 available from ladysewandsew.co.uk and empresmillis.co.uk
- Main quilt is quilted by Cath Brough (cumbrianlongarmquilting.co.uk)

FABRICS USED

- Background fabric is a Bella Solid in Bleached White by Moda.
- Print fabrics are from the Stellar collection by Rashida Coleman-Hale for Ruby Star Society.

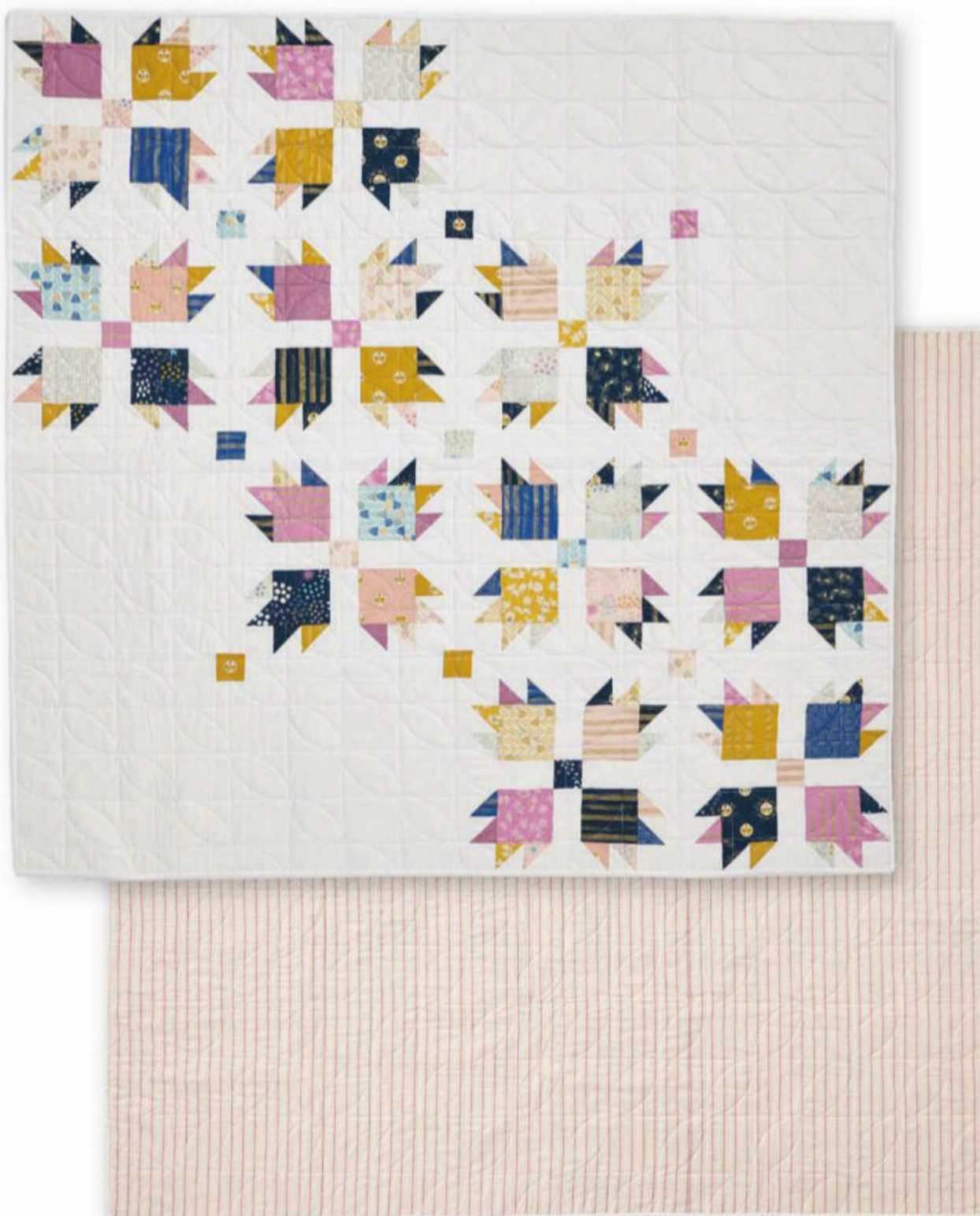

OPT FOR MODERN WHITE BINDING OR FRAME THE DESIGN WITH A CONTRASTING COLOUR

PREPARATION

1 Cut each print 10in square into four (4) 5in squares, by cutting in half both vertically and horizontally. In order to achieve a scrappy look, mix the prints up before subcutting as given in step 2. You will need at least one hundred and twenty five (125) 5in squares in total, but the more prints you use the scrappier your finished quilt will look. You will have some squares left over, which can be saved to make the coordinating cushion.

CUTTING OUT

- 2 From the 5in print squares cut in step 1, subcut a total of:
- Forty (40) 4½in squares.
 - Eighty (80) 3¼in squares.
 - Nineteen (19) 2½in squares.

- 3 From the background fabric cut:
- Six (6) 16½in x 14½in.
 - Eighteen (18) 14½in x 2½in.
 - Forty (40) 6½in x 2½in.
 - Eighty (80) 3¼in squares.
 - Forty (40) 2½in squares.
 - Seven (7) 2½in x WOF strips for the binding.

PIECING THE HST UNITS

- 4 Pair one background fabric 3¼in square with one print fabric 3¼in square. On the wrong side of the background square, draw a line diagonally from corner to corner.
- 5 Sew with a ¼in seam allowance on either side of the marked line. Cut apart on the marked line. Repeat to make a total





of one hundred and sixty HST units. Press and trim all of your HST units to 2½in square (Fig 1).

ASSEMBLING THE BLOCKS

6 For each block you will need:

- Sixteen (16) HST units.
- Four (4) print 4½in squares.
- One (1) print 2½in square.
- Four (4) background 6½in x 2½in.
- Four (4) background 2½in squares.

7 Sew two HST units together, oriented as shown. Sew to the top of one 4½in square (Fig 2). Sew one background 2½in square and two HST units in a strip,

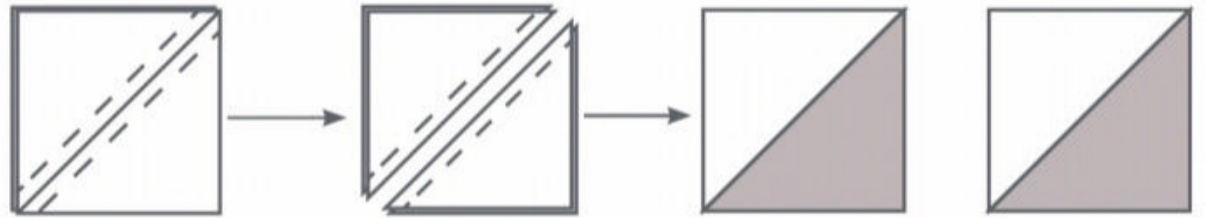

Fig 1

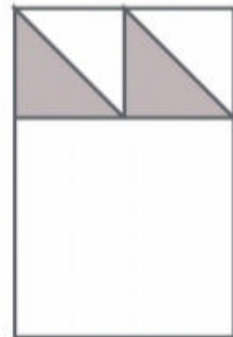

Fig 2



Fig 3

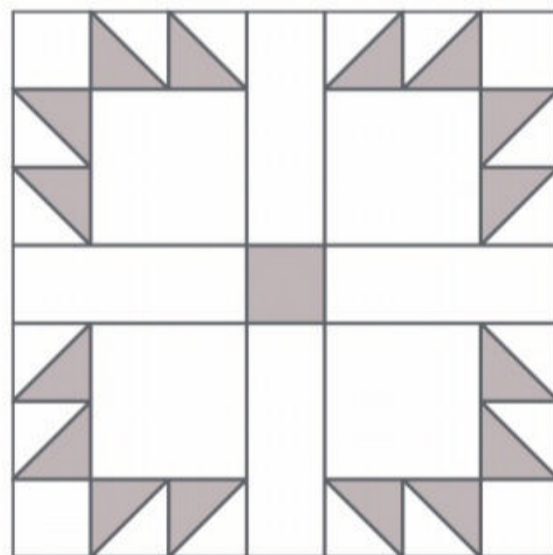
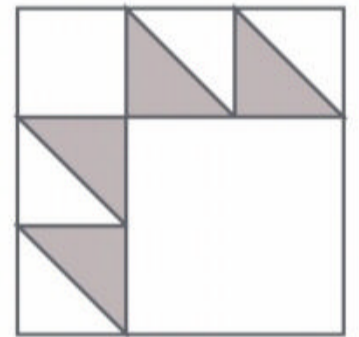
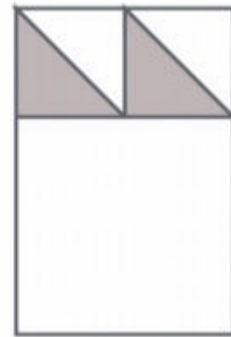

Fig 4

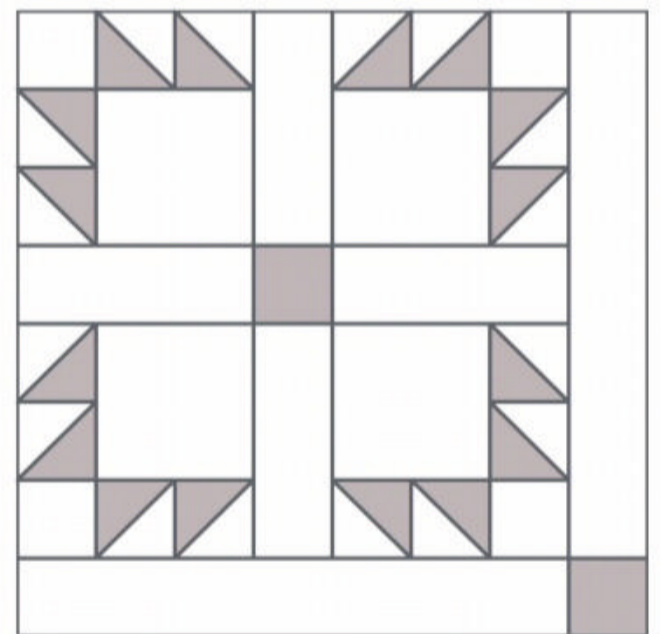

Fig 5

taking care to orient correctly. Sew the two units from step 7 together to make a corner unit (Fig 3).

8 Repeat step 7 to make a total of forty corner units.

9 Lay out four corner units, four 6½in x 2½in background rectangles and one 2½in print square as shown. Sew together in rows, then sew the rows together (Fig 4). Repeat to make a total of ten blocks.

ASSEMBLING THE QUILT TOP

10 Sew a 2½in x 14½in strip to the right edge of one of your blocks. Sew a 2½in print square to the end of a 2½in x 14½in background strip. Then sew this strip to the bottom of the block (Fig 5). Repeat this to make a total of seven sashed blocks.

11 Arrange all your blocks with the remaining background pieces as shown in Fig 6. Note that the 14½in x 16½in background pieces in the first three rows are arranged with the longer edges at the sides. In the last row, the 14½in x 16½in background pieces are arranged with the longer edges along the top and bottom.

12 Sew the two print 2½in squares to the bottom of the sashing strips. Sew one sashing strip to the bottom of the last block in the third row. Sew the units together in rows, then sew the rows together to complete the quilt top.

QUILTING AND FINISHING

13 Cut the backing fabric into two equal lengths. Remove the selvages and sew the two pieces together using a ½in seam. Press the seam open.



14 Press the quilt top and backing well. Make a quilt sandwich by placing the backing fabric right side down, the batting on top, then place the quilt top centrally and right side up. Baste the layers together using your preferred method.

15 Quilt as desired. Cath (cumbrianlongarmquilting.co.uk) quilted an all-over Orange Peel design using a longarm quilting machine. Trim off the excess batting and backing fabric and square up the quilt.

16 Sew the binding strips together end-to-end using diagonal seams. Press the seams open and trim the dog ears. Fold in half lengthways, wrong sides together, and press.

17 Sew the binding to the right side of the quilt, creating a neat mitre at each corner. Fold the binding over to the back of the quilt and hand stitch in place around the edge to finish.

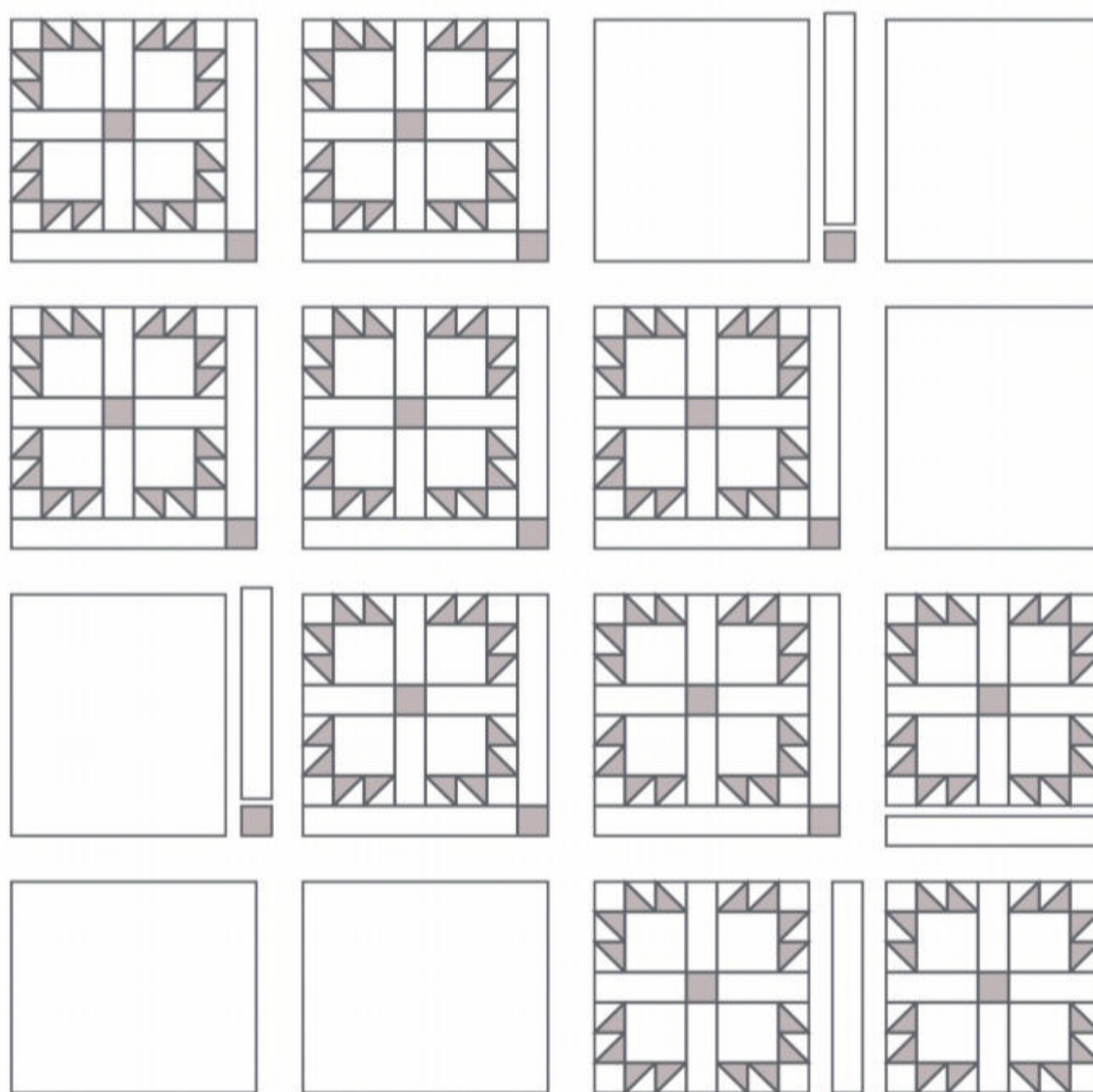
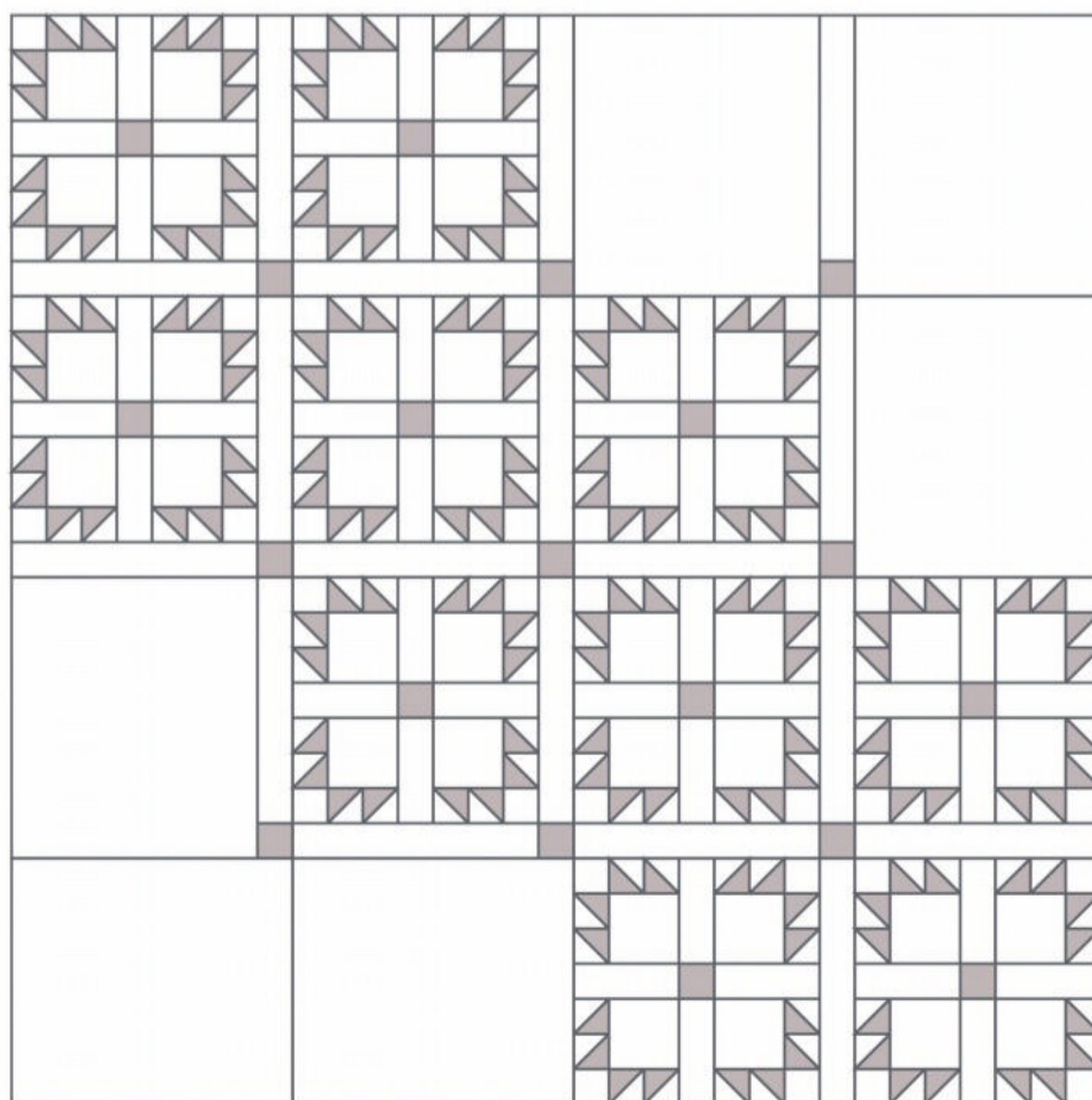

Fig5



Layout Diagram

YOU WILL NEED

To make the cushion:

- Background and backing fabric: 1yd
- Print fabrics: seventeen (17) 5in squares
- Lining fabric: $\frac{5}{8}$ yd
- Batting: 22in square
- Cushion insert: 18in square

FINISHED SIZE

- 18in square

**CUTTING OUT****1** From the print fabrics cut:

- Four (4) $4\frac{1}{2}$ in squares.
- Eight (8) $3\frac{1}{4}$ in squares.
- Five (5) $2\frac{1}{2}$ in squares.

2 From the background fabric cut:

- Four (4) $14\frac{1}{2}$ in x $2\frac{1}{2}$ in.
- Four (4) $6\frac{1}{2}$ in x $2\frac{1}{2}$ in.
- Eight (8) $3\frac{1}{4}$ in squares.
- Four (4) $2\frac{1}{2}$ in squares.
- Two (2) $18\frac{1}{2}$ in x $11\frac{1}{2}$ in for the back.

3 From the lining fabric cut:

- One (1) 22in square.



USE THIS CUSHION AS THE PERFECT EXCUSE TO FUSSY CUT SOME FUN PRINTS!

PIECING THE CUSHION FRONT

4 Follow steps 4–7 of the main quilt instructions to make four corner blocks. Join the corner blocks as in step 9 to make one block.

5 Sew a $14\frac{1}{2}$ in x $2\frac{1}{2}$ in background sashing strip to each side of the block and press. Add a $2\frac{1}{2}$ in main print square to each short end of the remaining $14\frac{1}{2}$ in x $2\frac{1}{2}$ in pieces. Press.

6 Sew the long sashing pieces to the top and bottom of the main block to complete the cushion front.

QUILTING AND FINISHING

7 Press the lining and cushion front. Layer your lining fabric right side down, then place the batting and cushion top right side up. Baste and quilt as desired. Trim the excess batting and lining fabric.

8 Hem one cushion back piece by pressing under one long edge by $\frac{1}{4}$ in

and again by $\frac{1}{4}$ in, so that the raw edges are enclosed. Stitch in place and repeat for the other cushion back piece.

9 With your cushion top right side up, lay your two backing pieces on top, right side down. Make sure the hemmed edges overlap in the middle and the raw edges of the cushion top align with the raw edges of the cushion backs. Pin in place.

10 Sew all the way around the outer edge with a $\frac{1}{4}$ in seam allowance, backstitching at the beginning and end. Trim the corners and turn the right way out, poking out the corners. Insert a cushion pad to finish.

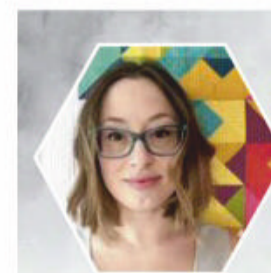
**Lou Orth**

Fabric addict Lou loves playing with colours and is constantly coming up with dreamy new quilt designs

➤ louorthdesigns.com

📷 [louorthdesigns](https://www.instagram.com/louorthdesigns)

DESIGNER PROFILE

Alyce Blyth

Pattern designer, sewing teacher and book author **Alyce Blyth** can't resist passing on her knowledge. We chatted about why she loves mini quilts so much and how helping others comes naturally to her



Where did the idea for your book *Mini Masterpieces* come from?

Some quilters are known for their Foundation Paper Piecing or for their love of triangles or curves. Some quilters, like me, just like a bit of everything! So when it came to narrowing down the concept for my book, I wanted to be able to include a wide variety of quilting techniques and tips that I love to play with in my own quilting. These combined to create the beginner-friendly book that is *Mini Masterpieces*.

As for the specific book concept of having a sampler quilt block and a mini quilt for each of the 12 techniques, the inspiration came from both my love of sampler quilts and also that fun, bite-sized accomplishment that comes from

making a quilt block. I like to describe *Mini Masterpieces* as me in a book... teaching, creativity and sampler quilt blocks loaded with quilting tips and tricks, all to encourage you to have confidence and explore your own creativity through fabric.

How long did it take to make the book – from coming up with the concept to having it in your hands?

All up, from first idea through discussions with Lucky Spool, through moving countries and states, dabbling in other book concepts, to finally signing the contract and then having *Mini Masterpieces* in my hands... about three and a half years. It was a long journey! But worth it.

What's your favourite thing about making mini quilts?

How fast they are to sew and how achievable the size is. Sometimes as quilters we feel that each quilt we make must be big and useful on sofas

or beds. But that larger size is daunting when you want to try a new quilting technique or skill – it's a big commitment! Mini quilts offer a small, achievable size that means we can try something new, but still have that feeling of accomplishment that comes with a finished project.

What do you do with all of your mini quilts once they're finished?

Well, my book samples are all unglamorously but safely tucked away in a tub under my bed! But the rest of my mini quilts become baby quilts, or doll quilts for my niece, wall-hangings or turned into a cushion. Cushions are my favourite finishing option, as they're just so practical and are well-used and loved in my house. I've lost count of how many have been kidnapped by my children, never to be seen again from the depths of their bedrooms!

Please tell us your first quilt was a mini quilt! How did you originally get into quilting, and what was that first quilt like?

My first quilt was certainly small, yes! It was the stereotypical baby quilt that many of us start with. Mine was a disappearing nine-patch made in very bright and multi-coloured orange, lime green and blue fabrics from the sales section in a big box craft store.

The quilt that inspired me to start was one that a friend of mine had made for her daughter. I was intrigued by the process and the fun

Below: Alyce enjoys sewing all kinds of techniques

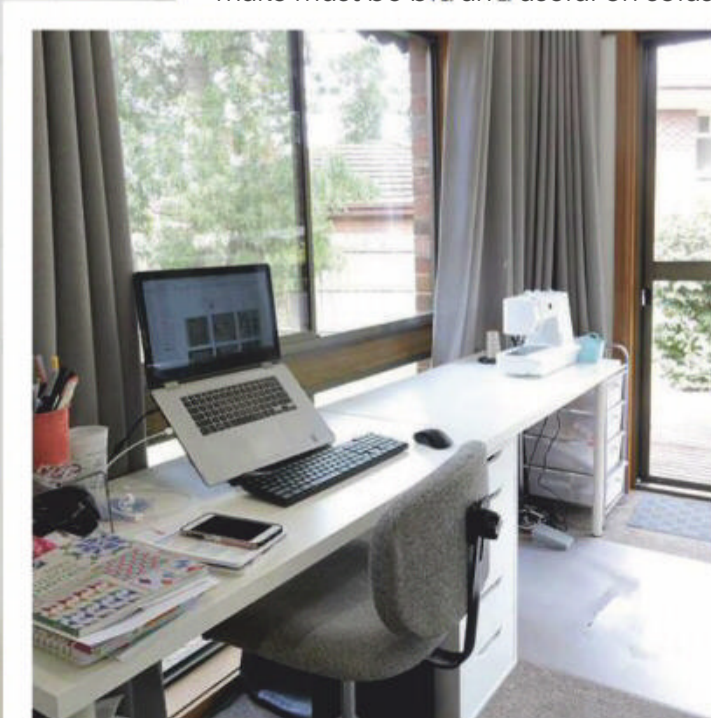



Above: Alyce's unique Origami Quilt pattern
 Right: *Mini Masterpieces* has an accompanying Aurifil thread box
 Below: Alyce loves mini quilts as they're a great way to learn a new technique



use of fabric colours and prints, as I had previously only seen really traditional fabrics used and they just weren't my cup of tea. The fabrics I used for my own first quilt certainly aren't my cup of tea now either, but we all started somewhere!

You have a background in teaching and regularly share tutorials – what is it about passing on your knowledge that you love?

Good question! To be totally on trend, I could simply say that I'm an Enneagram Type 2 [personality type], which means I love to help others and, for me, that's predominantly demonstrated in my love of teaching.

We read that you even love quilt maths... is there any part of quiltmaking that you don't enjoy?

Basting. And binding is a close second! I have never had good floor space at home to baste big quilts, so it always feels like a big chore to either borrow a friend's floor or even my church's hall floor, because I have to pack everything and drive there and back, and such. However, as I try to get any quilts larger than a big throw-size longarmed (I enjoy quilting, but my shoulders and back? Not so much), this does certainly reduce the amount of times I have to do it. As for binding, it used to be number one, but once I got machine

I love to help others and, for me, that's predominantly demonstrated in my love of teaching. I enjoy seeing quilters grow in their confidence and skills

So it is definitely something innately a part of who I am – I wanted to be a teacher from a very young age, and that's what I studied at university. And now those skills are being used in the quilting industry! I really enjoy seeing other quilters grow in their confidence and skills, and take that knowledge to conquer other quilt patterns.

binding down pat, it's really not so bad now.

Do you think that your time living in Japan had any influence on your design aesthetic?

I often say that if our four years in Japan had truly, deeply influenced my quilting aesthetic by the type of



DESIGNER PROFILE



Above: Alyce's sewing room is a bright and airy space that's always kept nice and neat!

quilting I saw regularly, I would be a scrap quilter who pieced by hand. And I most certainly am not that! So perhaps it's more the case that while I greatly admire and respect the work of Japanese quilters, it showed me where my true interests lay – machine piecing and working with blenders.

What do you enjoy about designing block of the month patterns?

I have quite the history of designing block of the month series! It comes back to that love of teaching a bit of everything and anything through



sampler quilts, and the achievability of committing to just one or two blocks per month.

My first BOM was a year-long, 25-block series of tutorials on my blog called The Bee Hive, where each quilt block created a secondary design when used in multiple across a quilt top without sashing, making for a good selection of blocks to use for quilting bees. Fun fact – this series was originally a book concept! I didn't have the time to write a book back then though, with two little children and while still living in Japan.

Since then I've done a Half-square Triangles BOM (Modern HST Sampler QAL), a Foundation Paper Piecing BOM (Milky Way Sampler), a starry sampler quilt (Aurora BOM), a row of the month quilt (Sunset Isle) and also three year-long BOM series with AccuQuilt Australia for which the latest is this year's sampler quilt pattern, Petals.

Do you also enjoy hosting quilalongs on Instagram?

I love it! Quilting is such a visual thing, that being able to easily share photos with the community and to mutually show off our gorgeous creations on a platform like Instagram is brilliant. I have also found that when running a longer QAL like my block of the month programs, it's useful to also have a Facebook group as a home base for community chatter.

A little birdie told us you're a perfectionist. How does this affect your sewing?

Ah yes, adding to my Enneagram personality Type 2 is a wing of Type 1: I like to help people, but am also a perfectionist! How this all works out in my sewing is not so much in being a perfectionist about my points all meeting, in fact, I'm a strong proponent of "Let it go" and "Finished is better than perfect" when it comes



Right: The Milky Way Sampler is just one of many of Alyce's block of the month quilt patterns



Above: The Ripples quilt design from Alyce's *Mini Masterpieces* book

to seams lining up perfectly. Instead, I struggle to feel creative and productive if my space is a mess, and there's piles everywhere and I can't see the table top or the cutting mat clearly. I've learned that what I classify as a mess is quite different from what someone else would classify as a mess! Classic perfectionist.

Do you prefer prints or solids?

I have a cheat answer – prints that work like solids. I do admire and love multi-coloured prints, especially a

good modern floral, but I find it much easier to work with blender prints that predominantly read as one colour.

Tell us about your sewing space!

I have a bright little space that is best described as a sunroom extension to the dining room. I love how much light my space gets, with two full walls

that's good for my perfectionist's need for order!

Can we expect any more books in the pipeline?

I can honestly say there is nothing happening right now, as I'm focusing on and enjoying the *Mini Masterpieces* QAL this year. But

I definitely plan on more books as that teacher within just can't resist! The book-writing process is hard, but I find it so fulfilling and satisfying

of windows (although that does mean a lack of wall space for storage!), and that I'm not closed off and tucked away from the rest of the household. As it's the main thoroughfare through to the back garden, and easily seen from the living room and dining room, it does mean I have to keep it somewhat tidy and the floor clear, so

I definitely plan on more as that teacher within just can't resist! The book-writing process is hard, but I find it so fulfilling and satisfying.



[blossomheartquilts.com](https://www.blossomheartquilts.com)
[blossomheartquilts](https://www.instagram.com/blossomheartquilts)

TACTILE TREAT

Back your play mat with a cuddly plush fabric for extra texture!





PLAY TIME

Sew the perfect set-up for tummy time with playful print fabrics and a sweet sunshine design!

BY KATE WEBBER

YOU WILL NEED

- Fabric A (centre) $\frac{7}{8}$ yd
- Fabric B (petals) 1yd
- Backing fabric (60in wide plush) $1\frac{1}{2}$ yds
- Batting: 60in square
- Basting spray (optional) or safety pins

FINISHED SIZE

- 44in x 38in

NOTES

- Seam allowances are $\frac{1}{2}$ in, unless otherwise noted.
- Press fabrics well before cutting.
- RST = right sides together.
- WOF = width of fabric.

FABRICS USED

- Fabric A is Forest Friends in Light Grey from the Under the Stars collection by Dashwood Studio.
- Fabric B is Twist in Honey, also by Dashwood Studio.
- Backing Fabric is Smooth Plush in Graphite.



WHY NOT USE SOME CONTRAST PRINT FABRICS TO MAKE YOUR PLAY MAT DOUBLE SIDED?



CUTTING OUT

- 1 From the centre fabric cut:
 - One (1) 31in x 27in. Along the top and bottom, mark $7\frac{3}{4}$ in from each corner. Also mark $13\frac{1}{2}$ in from the bottom. Draw a line between these marks to make a hexagon and cut off the corners (Fig 1).
- 2 From the petal fabric cut:
 - Six (6) 16in x $10\frac{1}{2}$ in.
- 3 From the backing fabric cut:
 - One (1) 31in x 27in. Mark and trim as in step 1.
 - Six (6) 16in x $10\frac{1}{2}$ in.
- 4 From the batting cut:
 - One (1) 35in x 31in.
 - Six (6) 18in x $12\frac{1}{2}$ in.

QUILTING THE CENTRE

- 5 Lay the centre hexagon right side up on top of the large batting rectangle. Spray or pin baste in place. Quilt as desired. Trim the excess batting even with the fabric.

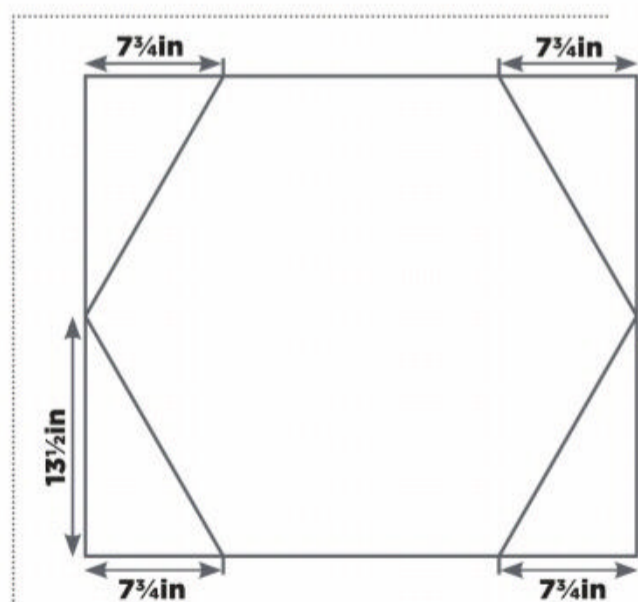

Fig 1

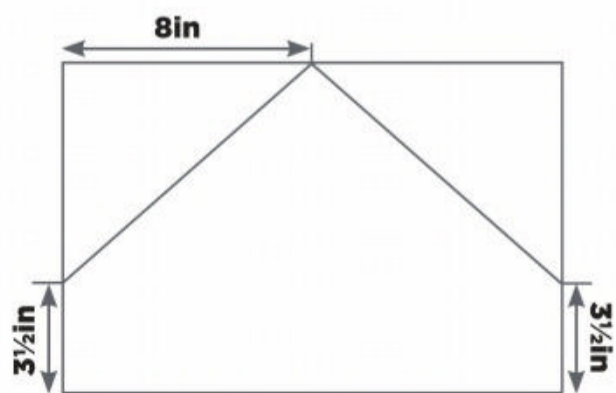
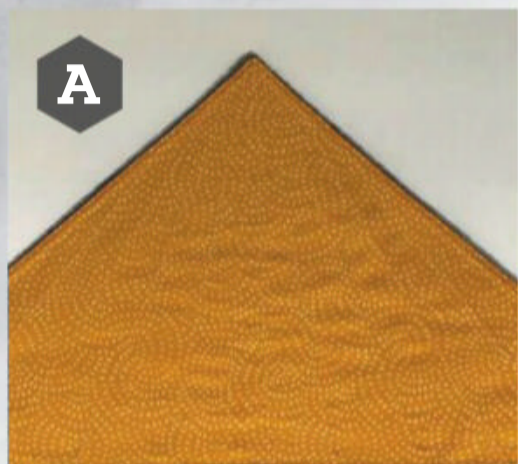

Fig 2

MAKING THE PETALS



A

ASSEMBLING THE PLAY MAT

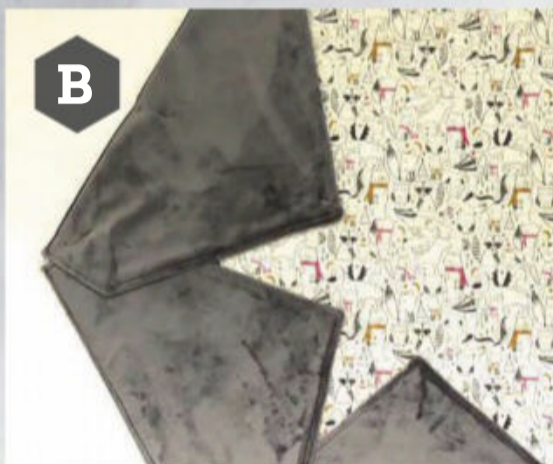

B

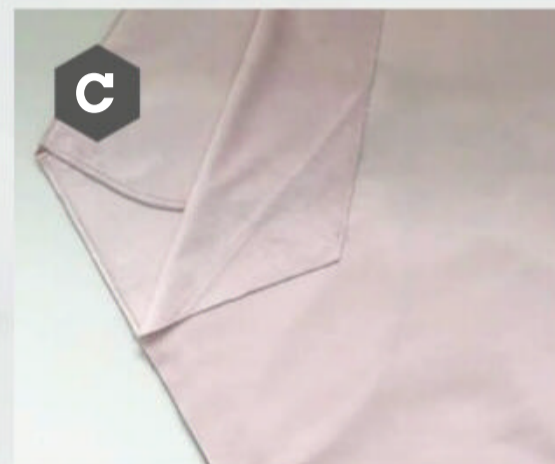

C



MAKING THE PETALS

6 Repeat the process outlined in step 5 to layer, baste, quilt and trim the six 16in x 10½in rectangles as desired, taking the petal shape into consideration.

7 To shape the rectangles into petals, mark the centre on the top long edge, and along each side mark 3½in up from

the bottom. Connect the marks and cut the corners off (Fig 2).

8 Repeat step 7 to trim the plush rectangles so that the nap runs towards the flat base of the petals.

9 Layer each quilted petal with a plush petal right sides together. Stitch with

TOP TIP

The generous ½in seam allowance helps as the plush fabric can stretch and move a little!

a ½in seam around four sides, leaving the base unsewn. Trim the seams to ¼in and turn the petals right side out.

10 Topstitch around the entire perimeter of each petal, ¼in from the edge (Fig A).

ASSEMBLING THE PLAY MAT

11 Lay out the quilted hexagon centre right side up. Align the raw edges at the base of each petal with each side of the hexagon, ensuring they are centred along each side (Fig B). Pin or baste in place, then stitch the petals to the hexagon with a ¼in seam allowance.

12 Leaving the petals folded into the centre, place the plush hexagon on top of the play mat, right side down (Fig C). Stitch around all the sides of the hexagon, leaving a turning gap on one side. Trim the corners and turn the play mat right side out.

13 Slipstitch the turning gap closed and topstitch around the edge of the hexagon to finish.



Kate Webber

Kate is a colourful quilter with an eye for fussy cutting and a passion for prints!

✉ katewebberdesigns.uk

📷 [katewebberdesigns](https://www.instagram.com/katewebberdesigns)

www.jbsewing.com

Finesse Quality Quilting Thread
From the Grace Company

*1500 Yards

* 60 Beautiful Colours

* 3 Ply 100% Polyester



Curlew Close
Queensway Meadows
NEWPORT
NP19 4SY
01633 284646

Gripoly Mills
Sloper Road
CARDIFF
CF11 8AA
02922 402418

A BIG
THANKS
TO OUR



**KEY
WORKERS**

DURING THE COVID-19 PANDEMIC

EUCALAN

CELEBRATING 30 YEARS!

delicate wash

BECAUSE WHAT YOU CREATE,
DESERVES THE BEST CARE

THE SPA TREATMENT FOR YOUR FINE WASHABLES

EUCALAN.COM

DENIM DAYS

Decorative stitches and pretty patches... give a pair of pre-loved jeans a quilty makeover!

BY SARAH GRIFFITHS



YOU WILL NEED

- One (1) pair of jeans
- Scraps of fabric for patches
- A selection of Sashiko and embroidery threads
- Sashiko needle
- Fusible web or fabric glue (optional)

NOTES

- Fabrics are from Sarah's stash.
- Press fabrics before cutting.
- Sarah used a combination of Sashiko threads and Aurifil Cotton Floss.

ADDING PATCHES

1 Cut your scraps of fabric into patches and audition them on your jeans. Move the pieces around, overlapping and trimming until you achieve a design you like. Take a photo of your design, so you can remember where each of your patches will go, in case things shift as you attach the patches.

2 To hold the patches in place, cut small squares or strips of fusible web. Following the manufacturer's instructions,



MIX AND MATCH YOUR FAVE FABRIC SCRAPS TO GIVE NEW LIFE TO YOUR CLOTHING

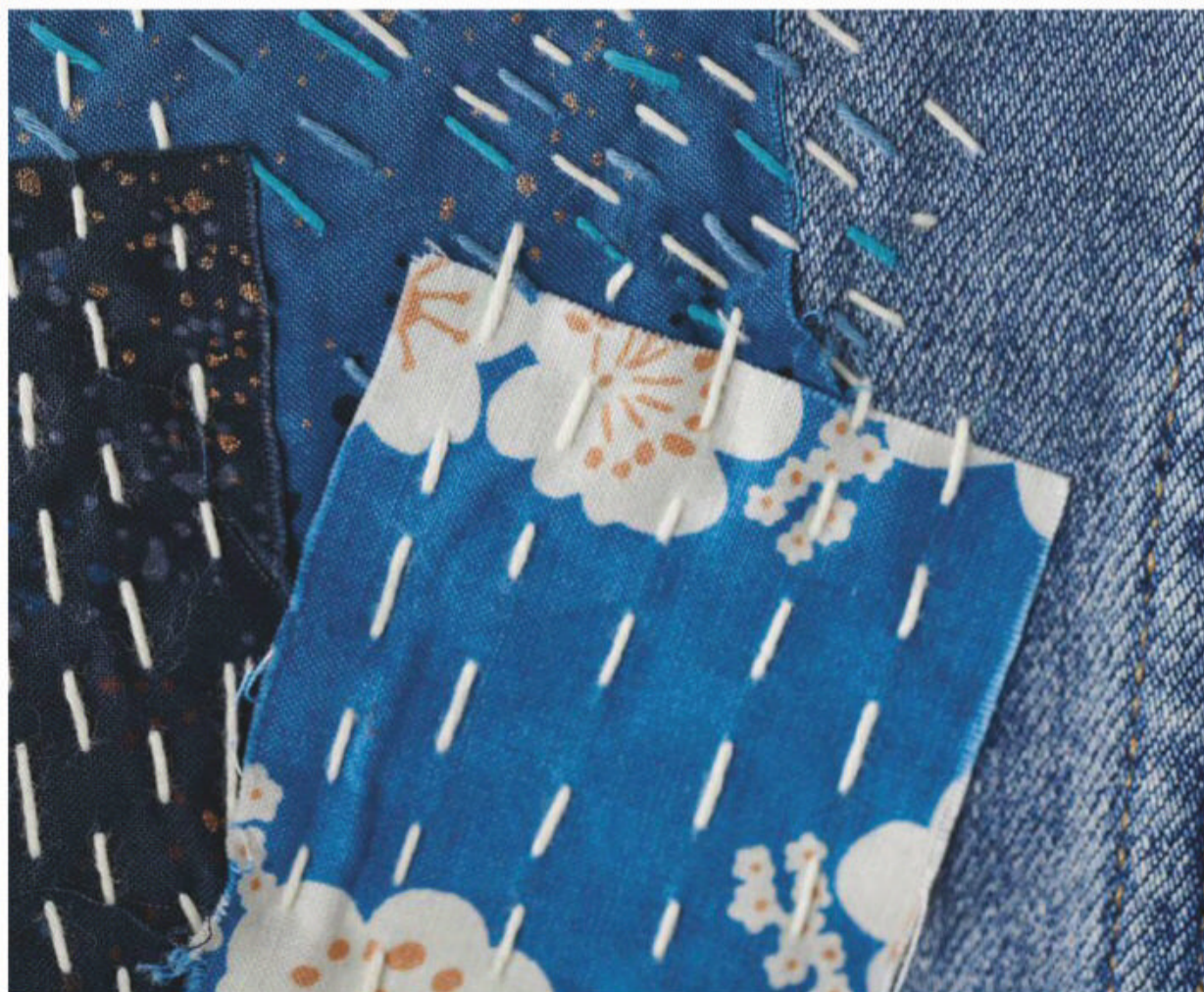

DARNING STITCH

Make a row of running stitches, with the stitches slightly longer than the gaps in between. Continue making rows, offsetting the stitches between rows (Fig A).

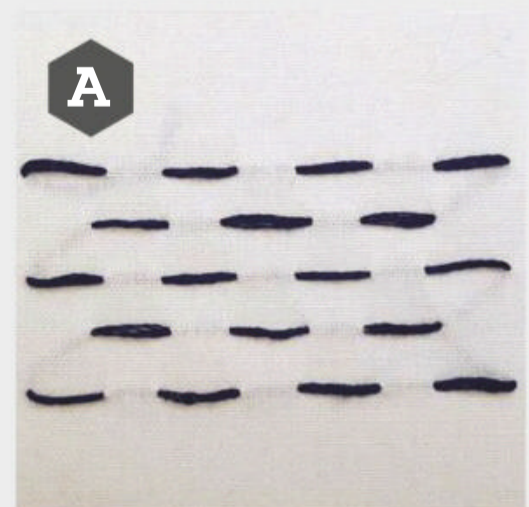

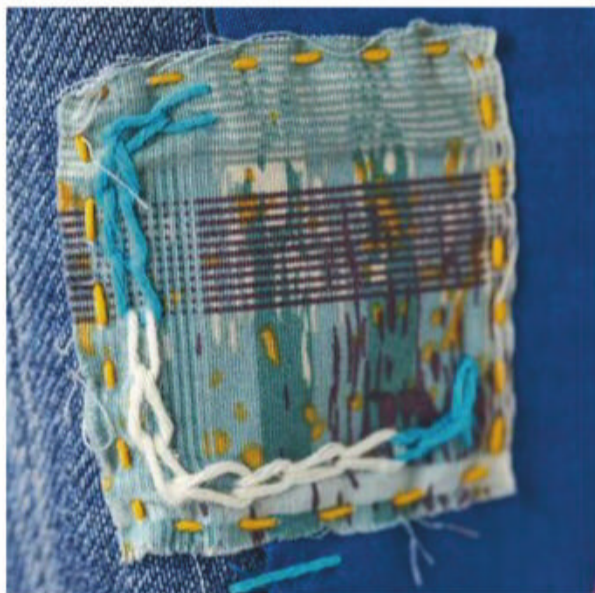

JAPANESE DARNING

Start with several rows of darning stitches. Begin connecting the first row with the second row using vertical stitches, joining the ends of the darning stitches (Fig B). Continue connecting each row with the next in this way, until all of the rows are joined (Fig C).

B

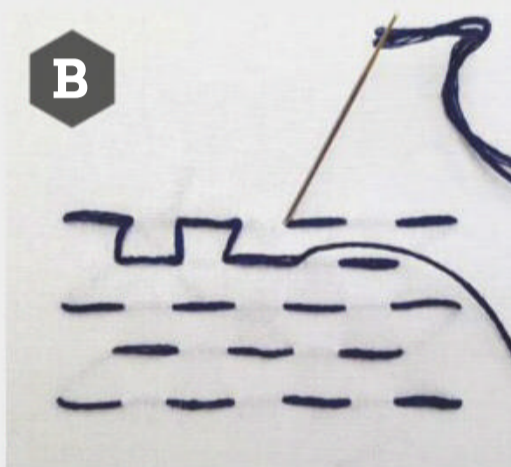

C

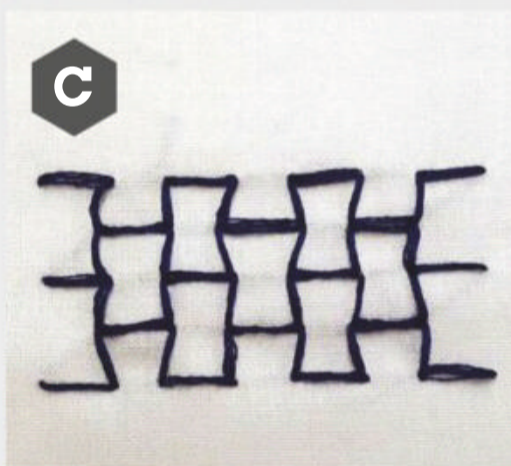

See the step photography for ideas on types of stitches to use. You can mark out lines of stitching using a removable fabric marker if you want a more uniform look. Sarah used free-hand embroidery for a free-form look.

5 Use blocks of stitches to cover entire patches, allowing the fabrics to fray around the outer edges. You can also extend stitching beyond patches onto neighbouring ones or across the denim. For reduced fraying, you can stitch around the outer edge of the patches.

6 Add some stitching details around pockets or over worn areas. Sarah also added a selvedge along the waistband, using slipstitches to secure.

PLAID FILLING STITCH

Stitch an even grid using long, straight stitches (Fig D). Use a second colour to make two stitches across each pair of the vertical grid stitches (Fig E). Use a third colour to make two stitches across pairs of both the grid and second colour stitches (Fig F).

D

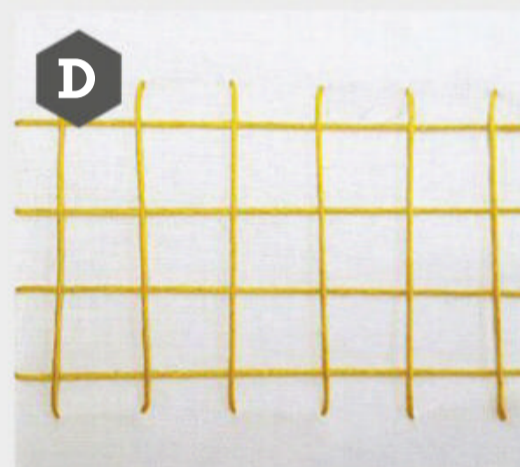

E

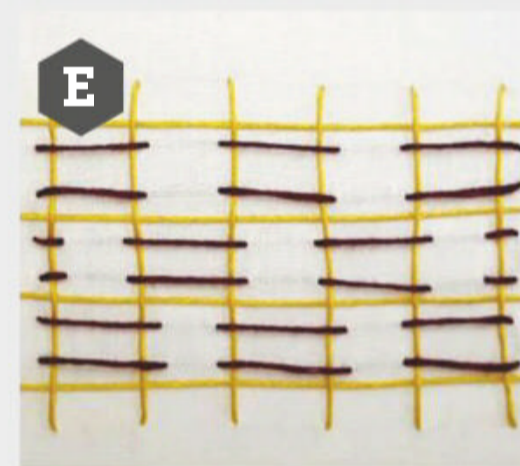

F

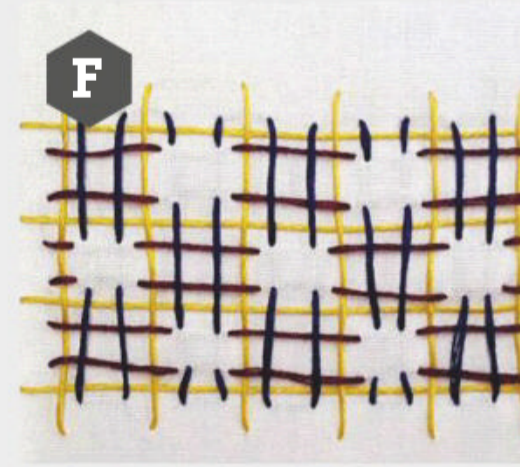

use to adhere your patches to the jeans, one at a time. You only need a small piece near the corners of your patches. Leave the outer edges of the patches free (approx 1/4in), so they can fray with wear. If you don't want to use fusible web, you can use a few dots of fabric glue or pin in place.

3 For large holes, place the fabric patch behind the hole and use pins or glue to hold in place around the outer edge. Make sure to allow any glue to dry completely, then secure with stitches around the hole.

4 Begin stitching your patches in place using Sashiko or embroidery threads.



Sarah Griffiths

LP&Q Senior Technical Editor Sarah spends her downtime daydreaming about more quilts than she could ever actually sew

[spindleandshears](#)

PRINT PERFECT

Take the time to track down the ideal fabric to match the piecing in this project





GOODNIGHT MOON

Sleep sweet with a pair of Foundation
Paper Pieced pillows topped off with
a delicate moon phase design

BY SUSI BELLINGHAM

YOU WILL NEED

Makes one (1) cushion:

- Gold solid fabric: one (1) fat eighth
- White background fabric: ½yd
- Grey print fabric: one (1) fat quarter
- Backing fabric: ½yd
- One (1) copy of each Full Moon, Half Moon and Crescent Moon FPP templates

FINISHED SIZE

- 15½in x 24in



NOTES

- Seam allowances are ¼in, unless otherwise noted.
- Press seams to one side, unless otherwise instructed.
- FPP templates include the seam allowances around the outer edge only.
- Pattern assumes WOF is 42in.
- For FPP, set your stitch length to 1.5.
- FPP = Foundation Paper Piecing.
- Press fabrics well before cutting.
- Moon fabrics supplied by Windham Fabrics (windhamfabrics.net)

FABRICS USED

- Moon fabric is Artisan Cotton in Yellow/Copper by Another Point of View for Windham fabrics.
- Riley Blake Blossom Tone on Tone in Grey on Black.
- Cotton and Steel Basics Freckles in Twinkle Metallic.
- Far Far Away 2 by Heather Ross for Windham Fabrics.

CUTTING OUT

1 From the grey print fabric cut:

- One (1) 16in x 15½in.

2 From the backing fabric cut:

- One (1) 16in x 21½in.
- One (1) 16in x 8in.

3 Using the templates as a guide, cut the fabric pieces for each section of the FPP templates, making sure the pieces will be at least ¼in larger than the section they will cover, all the way around.

SMALL FLICKERS OF METALLIC PRINTS ADD TO THE WHIMSICAL NIGHTTIME DESIGN

PIECING THE FPP MOONS

4 Foundation Paper Piece the Full Moon template as follows. Place the fabric piece for Section 1 right side up on the unprinted side of the template against the section. Ensure that the fabric covers the whole section, plus at least ¼in all around. Pin in place.

5 Place the Section 2 fabric piece right side down on top of the Section 1 piece, matching up raw edges on the side where Sections 1 and 2 will be joined and making sure that when folded back along the seam line, Section 2 will be covered by the fabric plus at least ¼in all around. Pin in place.

6 Turn the template over to the printed side and stitch along the marked line between Sections 1 and 2, backstitching at the beginning and end of the seam. Fold the template away from the seam and trim to ¼in. Fold the template back, turn the work to the fabric side, flip Section 2 open and then press.





7 Continue working in this way to piece the remaining sections on the FPP template, in numerical order. Trim along the dotted seam allowance line. Remove the paper from the back of the template.

8 Repeat steps 4–7 to piece one copy each of the Half Moon and Crescent Moon templates.

ASSEMBLING THE PILLOW FRONT

9 Sew the moons together into one strip, pressing seams open (Fig A). The strip should measure 16in x 9½in.

10 Join the grey print piece to the left side of the FPP moon panel, along one 16in edge. Sew across the seam allowance using a zigzag stitch to prevent the fabric from fraying. Press the seam to one side (Fig B).

FINISHING THE PILLOW

11 Take one backing piece and press under ¼in along one 16in edge. Press under ¼in again to enclose the raw edge. Topstitch or zigzag stitch in place. Repeat for the remaining backing piece.

12 Place the pillow front right side up. Place the smaller backing piece on top, right side down, aligning the raw edges at one side, the top and bottom (Fig C). Baste in place. Place the larger backing piece on top, also right side down, aligning at the other side of the cushion (Fig D). The hemmed edges will overlap in the centre. Baste in place.

13 Stitch all the way around the outer edge of the cushion. Then zigzag stitch around the outer edge within the seam allowance. Clip the corners and turn right side out to finish.

ASSEMBLING THE PILLOW FRONT

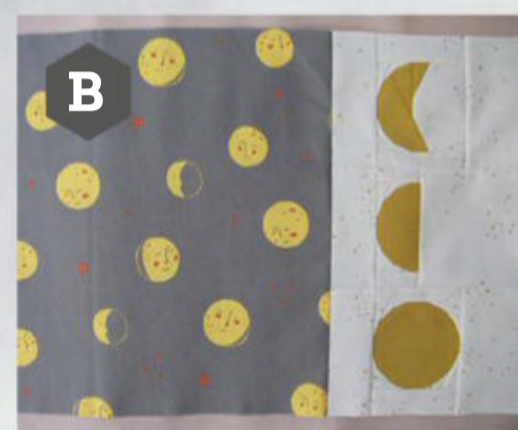
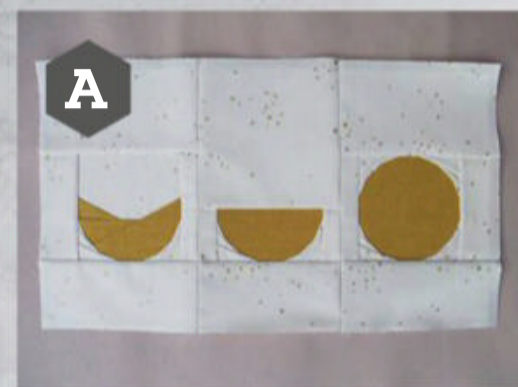

FINISHING THE PILLOW

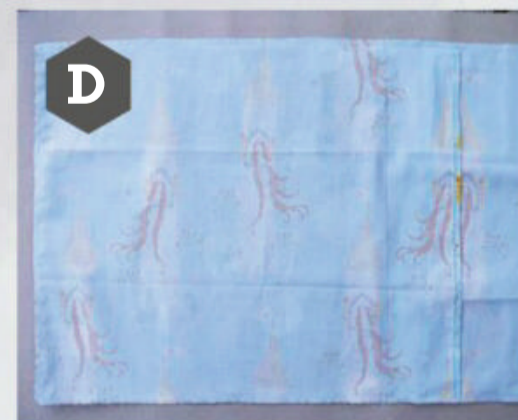

Susi Bellingham
 FPP master Susi has a head full of ideas by day and sews up her crafty plans by night
 tinytoffeedesigns.blogspot.de
 lillaluise

GOODNIGHT MOON

Full Moon template
ENLARGE 200%

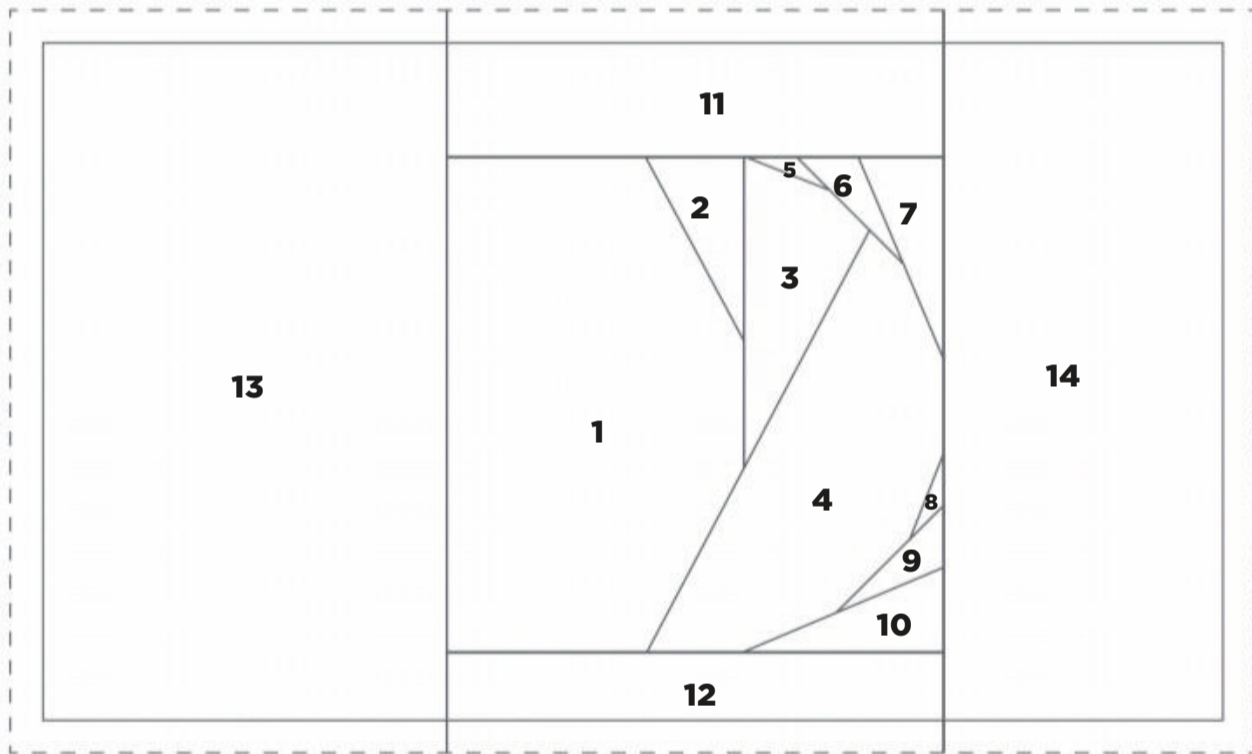
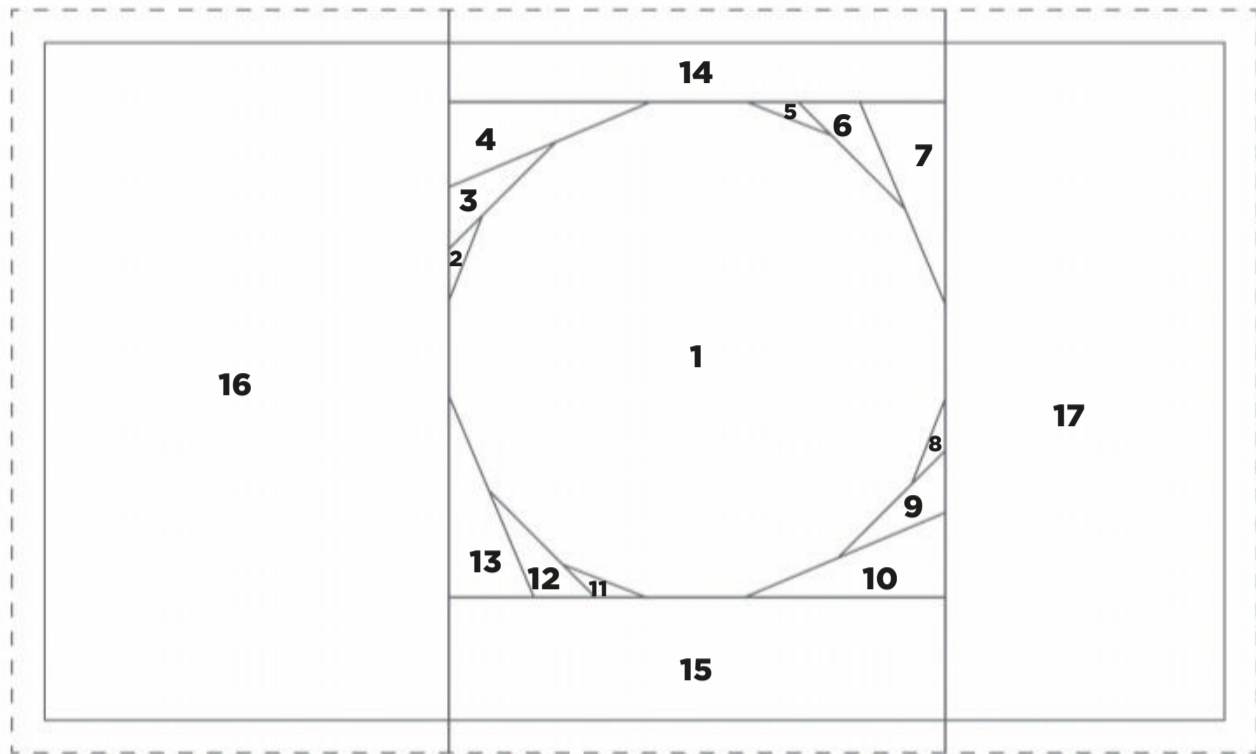

GOODNIGHT MOON
Crescent Moon template
ENLARGE 200%

GOODNIGHT MOON

Half Moon template
ENLARGE 200%

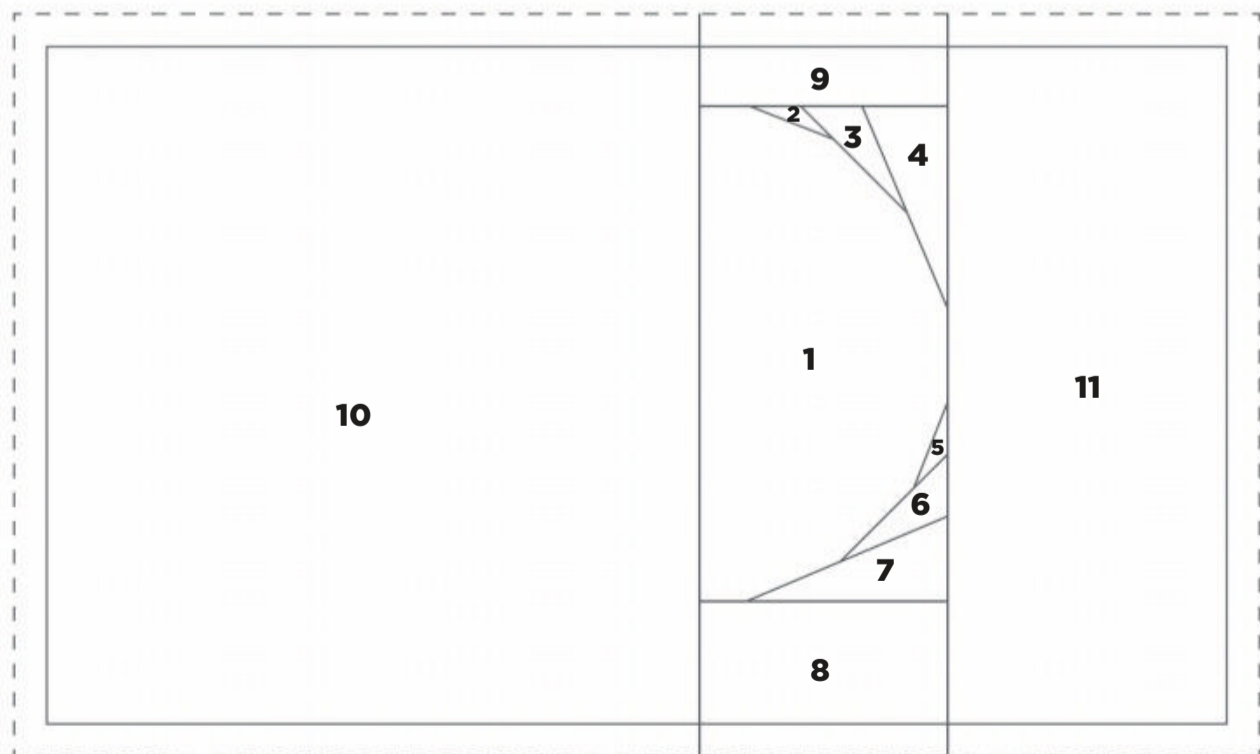

OVERSEAS READERS

13 ISSUES FOR JUST \$39.95 WHEN YOU SUBSCRIBE TODAY!*



UK
READERS
SEE P24

SAVE
78%!

- \$39.95 for 13 issues (1 year subscription), **saving 78%** or \$141.92!
- **OR Try 3 issues for \$9.95** and then pay just \$14.97 by quarterly continuous credit.
- Subscription prices **include delivery** – Never miss an issue!
- 13 issues a year (1 year subscription)

ORDER NOW – DON'T MISS OUT!

SUBSCRIBE TODAY!

US & Canada

Subscribe online at: www.buysubscriptions.com/LPPUS20

You can contact our customer service team by phone at 855-827-8639.

(Customer service hours are 8am-8pm Eastern time.)

Europe **€86.99 – 1 Year

Rest of World **£94.99 – 1 Year

Subscribe online at: www.buysubscriptions.com/LPP87

Or call +44 (0) 1604 973 754 and quote LPP87

*North American savings compared to 13 full priced issues at \$13.99 from the US newsstand and customers will be charged in \$. **Europe & ROW newsstand pricing varies by territory so no saving is expressed. This offer is for new print subscribers only. You will receive 13 issues in a year. Prices correct at point of print and subject to change. European and RoW subscribers: if you are dissatisfied in any way you can write to us or call us to cancel your subscription at any time and we will refund you for all unmailed issues. N. American subscribers: Minimum subscription terms 12 months. If at any time during the first 60 days you are dissatisfied in any way, please notify us in writing and we will refund you all unmailed issues. Offer ends: 10th January 2021

The new home of
Quilting

gathered.

Discover your next craft project



NEW

- 1,000s of free patterns
- Step-by-step tutorials
- Video guides



Explore fresh project ideas for all your favourite crafts with the **brand new website** for makers everywhere. Discover easy-to-follow patterns and tutorials for crochet, knitting, sewing, quilting, papercraft and stitching, and learn new skills from experts you can trust.

www.gathered.how





FELT FRIENDS

Snip and stitch a pair of perky cushions with easy-use templates and fuss-free fabrics!

BY JANE FOSTER

YOU WILL NEED

Makes one (1) cushion

- White fabric: ½yd
- Black felt: 20in x 14in
- Scrap of ribbon for side tab (optional)
- One (1) copy of either Face 1 or Face 2 template

FINISHED SIZE

- 14in square



NOTES

- Seam allowances are ¼in, unless otherwise noted.

CUTTING OUT

1 From the white fabric cut:
 ■ Two (2) 14½in squares.

2 From the black felt, cut all the pieces for the face using the template, or create your own eyes, mouth, nose and hair by cutting your desired shapes (Fig A).

WHY NOT GO FREE-HAND AND MAKE CUSHIONS THAT LOOK LIKE YOU AND YOUR FRIENDS?!



MAKING THE CUSHIONS

3 Lay one of your white squares right side up and begin placing the felt shapes on top. Start with the nose and mouth in the centre. Then place the eyes either side (Fig B). Then add the hair in place, working from the centre outward (Fig C).

4 Once you're happy with the placement of your pieces, pin in place well. Trim



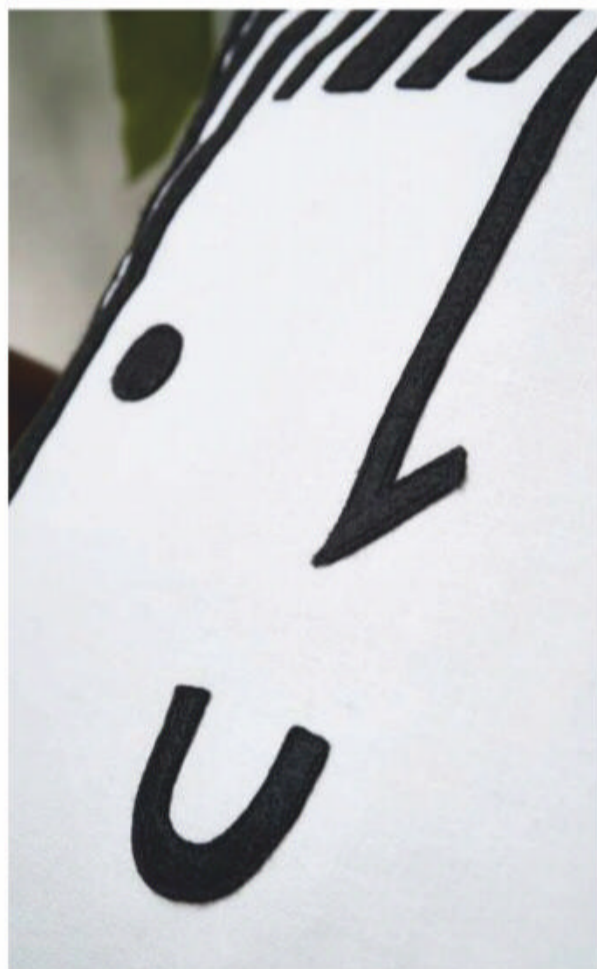

any pieces that overhang the edge of the panel, leaving approx ¼in above the edge of your fabric (Fig D).

5 Sew the pieces in place by machine, removing the pins as you work. Increase your stitch length to between 3.0 and 4.0.

6 For the long, thin pieces, start at the upper edge and stitch down one side. Pivot with the needle down to sew across the bottom, and pivot again to sew back up to the top (Fig E).

7 For the eyes and mouth, carefully stitch in place, then pull the thread tails to the back of the work and knot to secure.

8 Once all pieces are stitched in place, press on the wrong side to set the stitches. Trim any overhanging felt pieces level with the edge of the white background square to complete the cushion front.

9 To add a ribbon tab, fold your ribbon in half and place at the side of the cushion front, aligning raw edges. Baste in place. Place the cushion front RST with the remaining 14½in square.

10 Pin, then sew around the outer edge, leaving an approx 10in gap in the centre of the bottom edge for turning and

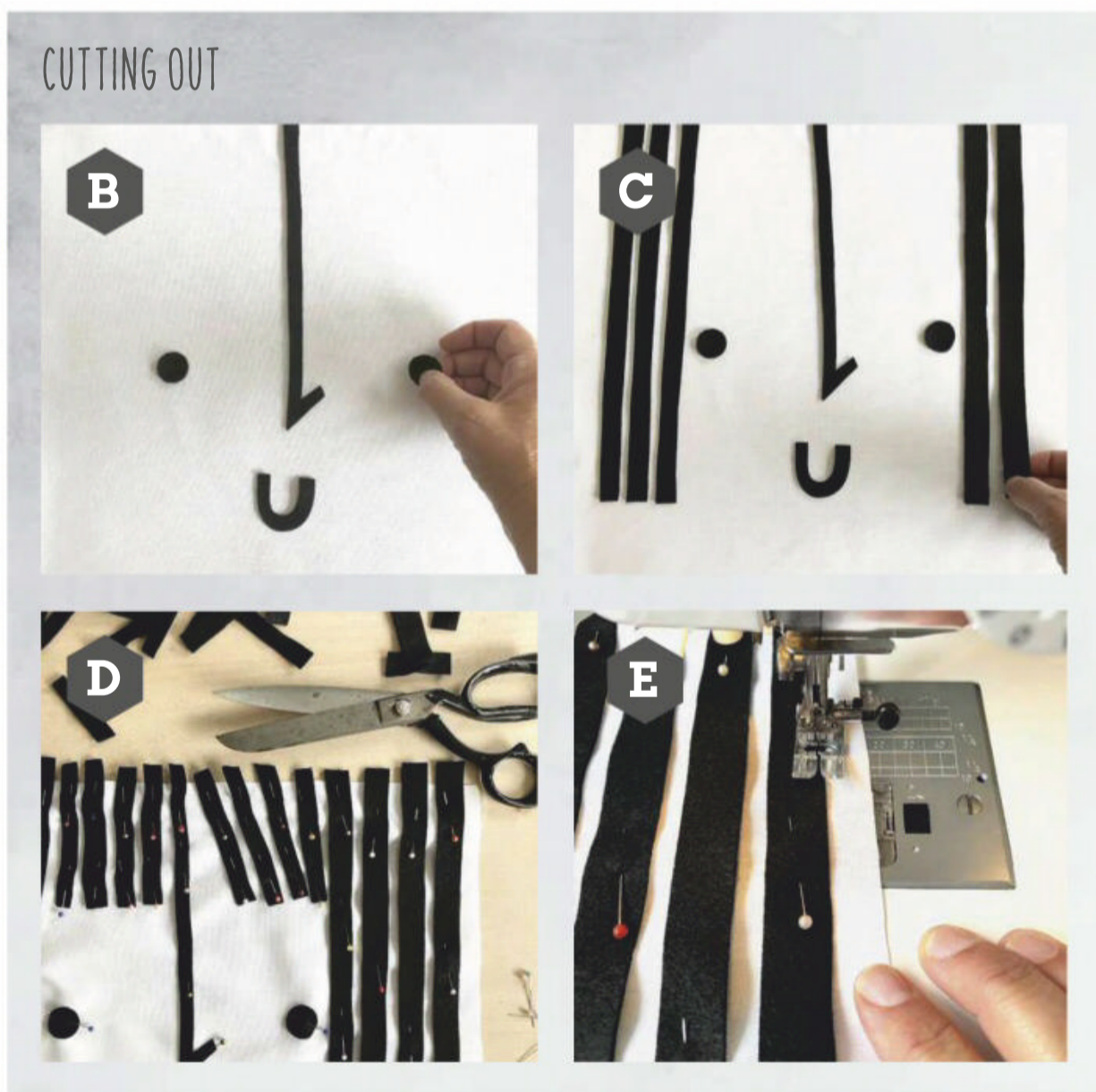

stuffing. Backstitch at the beginning and end of your stitching.

11 Turn the cushion right side out and press. Put a cushion insert inside or fill with toy stuffing. Sew the turning gap closed using a ladder stitch to finish.



Jane Foster
Jane is an illustrator, author and textile designer who loves bold designs that appeal to kids and adults
janefoster.co.uk
[janefosterdesigns](https://www.instagram.com/janefosterdesigns)

FELT FRIENDS

Face One templates

ENLARGE 200%

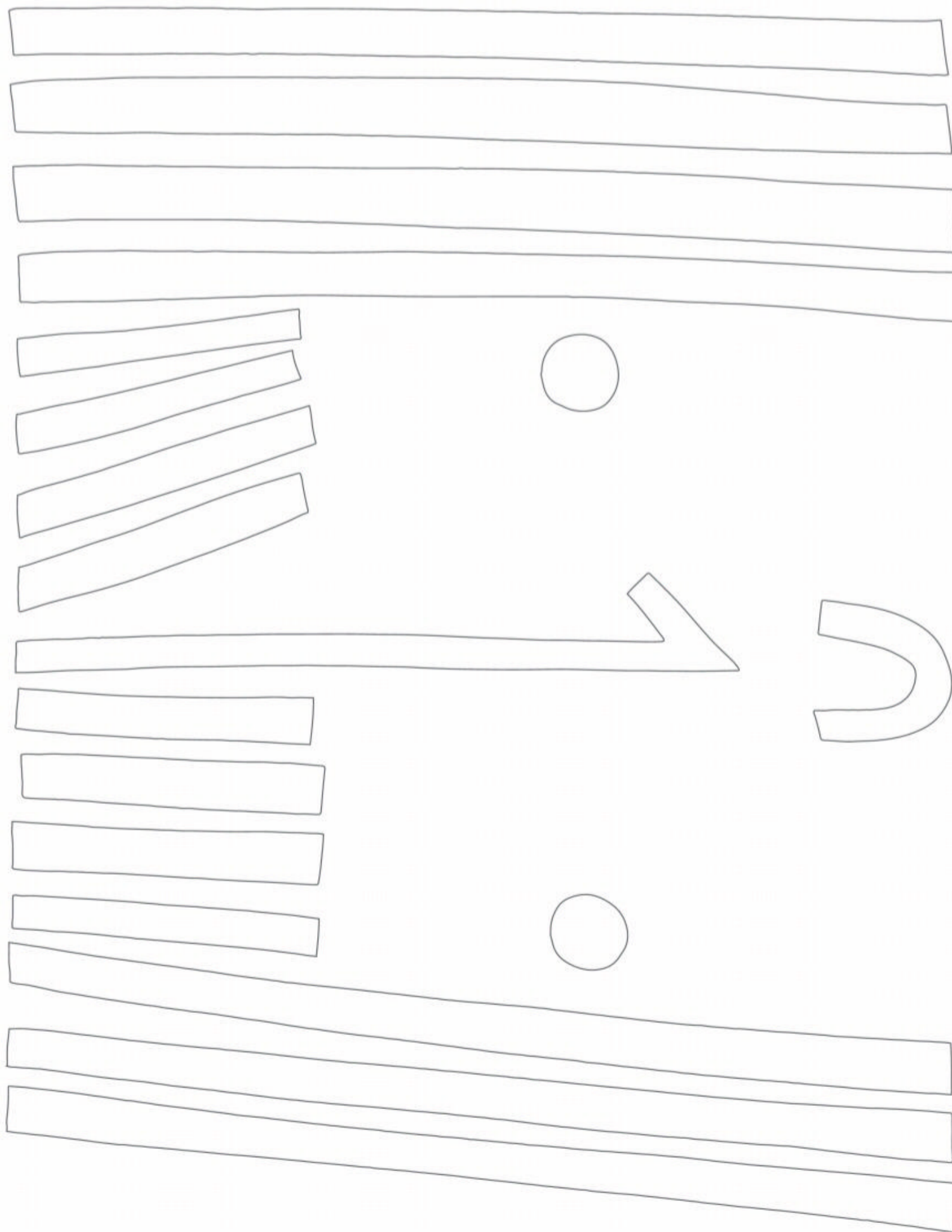

FELT FRIENDS

Face Two templates

ENLARGE 200%

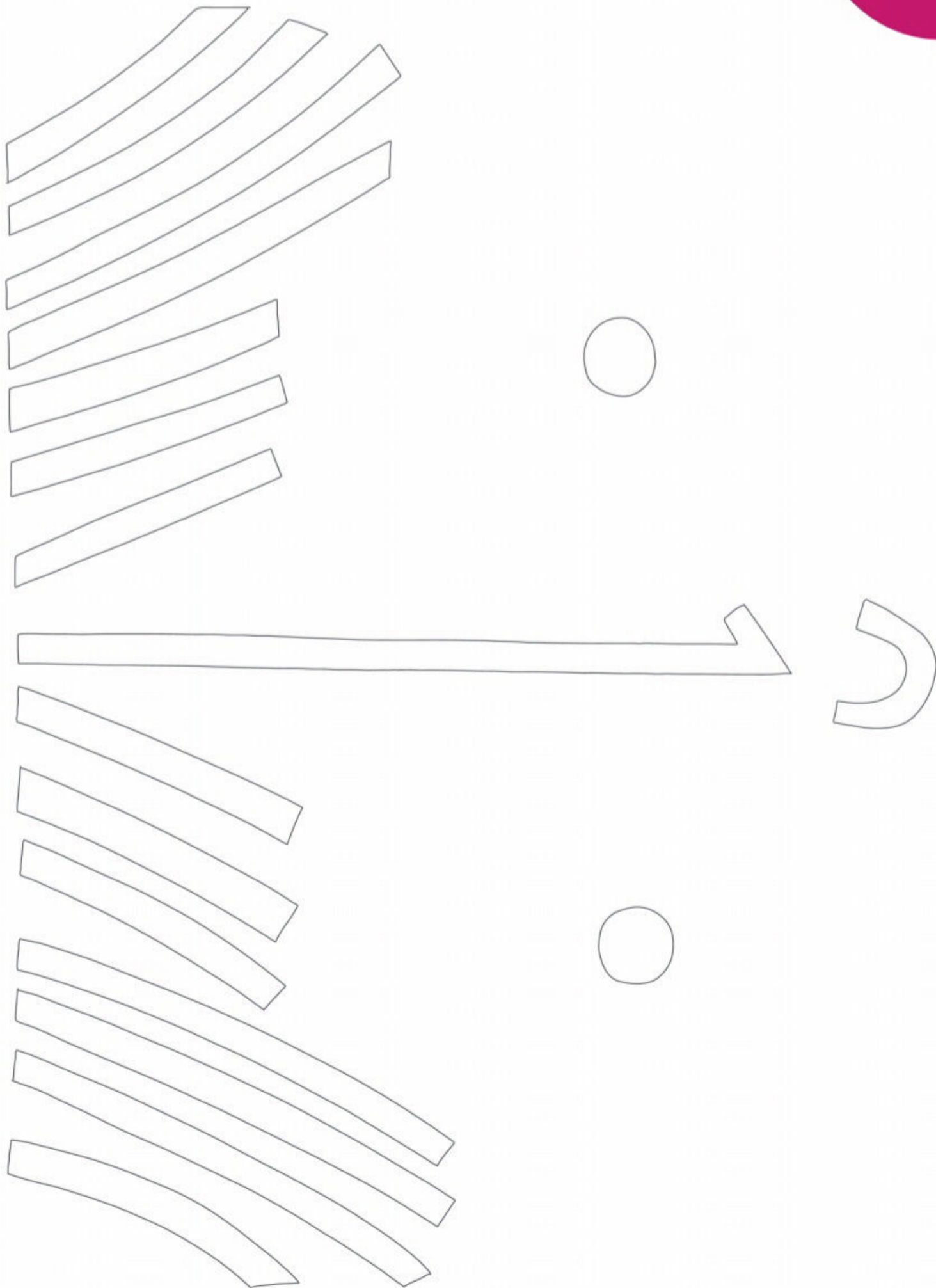

SUMMER SAVINGS

INTRODUCTORY OFFER

Try a subscription for just £5*

Take advantage of our great trial offers and subscribe to your favourite magazine today. Or why not try a new one?

Food



3 ISSUES FOR £5



3 ISSUES FOR £5



3 ISSUES FOR £5

Homes and Gardening



3 ISSUES FOR £5



3 ISSUES FOR £5



3 ISSUES FOR £5



3 ISSUES FOR £5

Lifestyle



3 ISSUES FOR £5

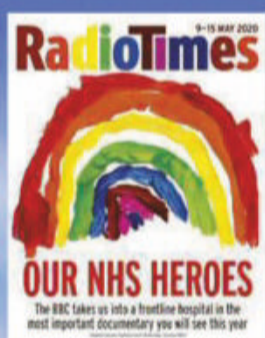

6 ISSUES FOR £1



3 ISSUES FOR £5

Science and Nature



3 ISSUES FOR £5



3 ISSUES FOR £5



3 ISSUES FOR £5



3 ISSUES FOR £5

History



3 ISSUES FOR £5



3 ISSUES FOR £5

Sport



3 ISSUES FOR £5



3 ISSUES FOR £5

Craft



3 ISSUES FOR £5



3 ISSUES FOR £5



3 ISSUES FOR £5

GREAT REASONS TO SUBSCRIBE:

- Subscriptions for just £5*
- Save up to 35% after your trial period
- Enjoy easy and convenient **delivery direct to your door**
- Never miss an issue
- Perfect summer reading

YOUR TWO EASY WAYS TO ORDER:

Order online at

buysubscriptions.com/SS20SP

or call our hotline: 0330 053 8660[†] **OFFER CODE SS20SP**

SEE OUR
FULL RANGE
OF MAGAZINES
ONLINE

Trusted
Service Award
★★★★★
2020 feefo

*This offer closes on 31st August 2020 and is valid for UK delivery addresses and by direct debit only. The discounts shown are savings calculated as a percentage of the full shop price, excluding Radio Times and Match of the Day which are calculated as a percentage of the basic annual rate. For overseas rates visit www.buysubscriptions.com. Should the magazine ordered change in frequency, we will honour the number of issues and not the term of the subscription. You are free to cancel your subscription at any time - if you cancel within 2 weeks of receiving your penultimate issue you will pay no more than the trial rate, this is with the exception of Radio Times and Match of the Day, which you will need to cancel 3 weeks before the trial is due to end. Radio Times and Match of the Day are published weekly. The Basic Annual UK Subscription rate for Radio Times is £193. This price is for one year and includes the Christmas double issue and a contribution towards postage. The Basic Annual Rate for Match of the Day is £117 for one year. These rates are correct at time of printing. We run trial offers throughout the year to give our customers an opportunity to try a new title before committing to a long term subscription. These are introductory offers and we reserve the right to reject or cancel any application for a trial subscription offer if the customer has previously purchased a trial offer for the same magazine or any other magazine in the Immediate Media portfolio. For a full list of our titles visit buysubscriptions.com/portfolio. UK calls will cost the same as other standard fixed line numbers (starting 01 or 02) and are included as part of any inclusive or free minutes allowances (if offered by your phone tariff). Outside of free call packages call charges from mobile phones will cost between 3p and 55p per minute. Lines are open Mon to Fri 9am - 5pm.





SASHIKO SHOPPER

Slow down and settle into some soothing hand stitching to add swoon-worthy texture to a stylish tote bag design

BY DEBBIE VON GRABLER-CROZIER

YOU WILL NEED

- Dark grey fabric: ¾yd
- Mid grey fabric: 1yd
- Lining fabric: 1½yds
- Fusible batting (36in wide) 1½yds
- Fusible interfacing (20in wide) ⅓yd
- Sashiko thread
- Leather: 5in x 30in
- Eight (8) copper rivets
- One (1) copy each of Templates 1, 2 and 3

FINISHED SIZE

- 24in x 25in



NOTES

- Seam allowances are ¼in, unless otherwise stated.
- Press seams to one side.
- Templates include seam allowance.
- RS = right side.
- Debbie used Vliseline H630 fusible batting and S320 fusible interfacing.
- Debbie used 12wt thread in 2123 and 1231 from Aurifil (aurifil.com)

FABRICS USED

- Fabrics are both Essex Yarn Dyed Linen by Robert Kaufman in Charcoal and Graphite.
- Lining fabric is a Kona Cotton Solid by Robert Kaufman in Key Lime.

PREPARING THE EMBROIDERED PIECES

1 Using a removable fabric marker, measure and mark a 13¼in x 25in rectangle on your dark grey fabric.

2 Embroider the 13¼in x 25in piece. To work the pattern, Debbie used a water soluble pen to mark the piece as shown in Fig 1. Then she filled in the areas with a combination of running and cross stitches in two colours. Once complete, trim to 13¼in x 25in along your marks (Fig A).

3 Repeat steps 1–2 to mark, embroider and trim a Template 1 and Template 3 piece from the dark grey fabric, and a

LEATHER AND COPPER HANDLES GIVE THIS HANDMADE BAG A PROFESSIONAL FINISH

Template 2 piece from the mid grey fabric. Refer to the photography for design ideas, or embroider as desired.

CUTTING OUT

4 From the mid grey fabric cut:
 ■ One (1) 26in x 25in (rear panel).
 ■ Two (2) 26in x 3¼in (lining top).

5 From the lining fabric cut:
 ■ Two (2) 26in x 22¼in (front and back panel).
 ■ Four (4) 9in x 5½in (slip pockets).

6 From the fusible batting cut:
 ■ Two (2) 26in x 25in.

7 From the fusible interfacing cut:
 ■ Two (2) 8in x 4½in.

8 From the leather strip cut:
 ■ Four (4) 1in x 27in (handles).
 ■ Two (2) ¾in x 23in (ties).

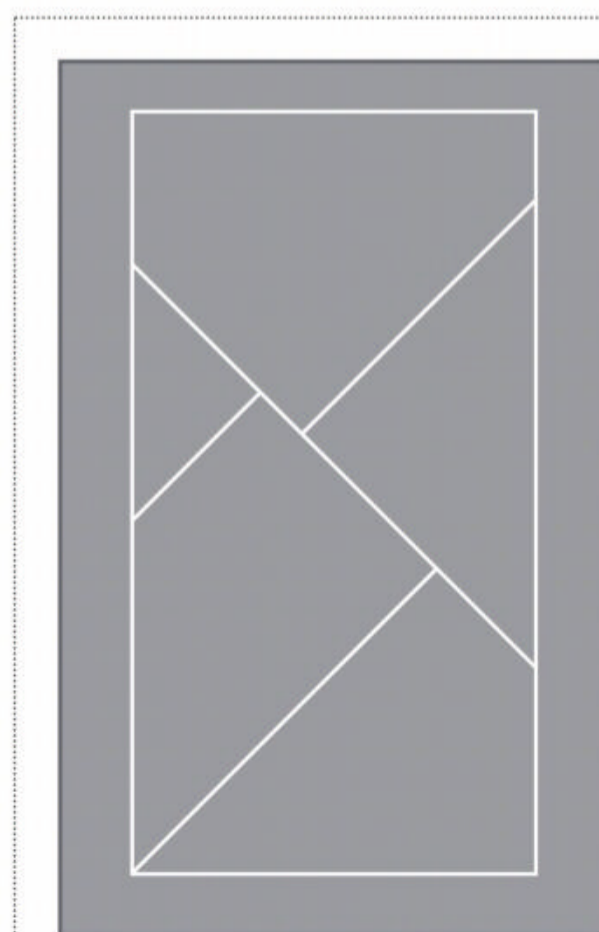

Fig 1



MAKE THE HANDLES

9 Glue two leather handle strips wrong sides together. Repeat with the other two strips. Allow to fully dry.

10 Once dry, topstitch all the way around each handle. Make two holes at each end for the rivets, using a leather punch tool (Fig B).

PREPARE THE SLIP POCKETS

11 Fuse one interfacing piece to the wrong side of one of the slip pocket pieces, centring the interfacing.

12 Place the interfaced slip pocket piece right sides together with a second, uninterfaced piece. Sew around the outer edge, using a $\frac{1}{2}$ in seam allowance, and leaving a turning gap in the centre of one long edge. Backstitch at the beginning and end of the seam.

13 Trim the seam allowance to $\frac{1}{4}$ in and clip the corners (Fig C). Turn RS out through the turning gap. Push out the corners and press, turning the seam allowance to the inside at the gap.

14 Repeat steps 11–13 with the remaining two slip pocket pieces.

MAKE THE LINING

15 Join a mid grey lining top piece to each of the lining front and back panels, along the 26in edge. Press the seam allowance towards the lining and topstitch just below the seam.

16 Take one of the lining pieces from step 15 and place RS up on your work surface. Measure 6in from the top and centre one slip pocket on top. Make sure the edge of the pocket with the turning gap is at the bottom. Pin in place.

PREPARING THE EMBROIDERED PIECES

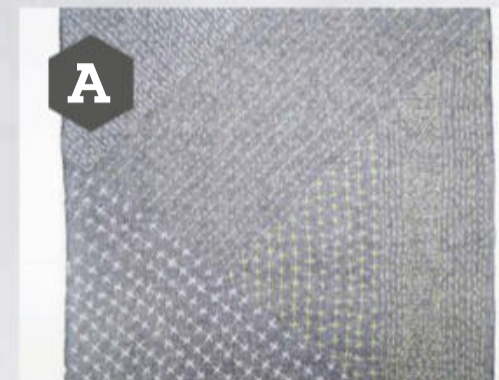

MAKE THE HANDLES

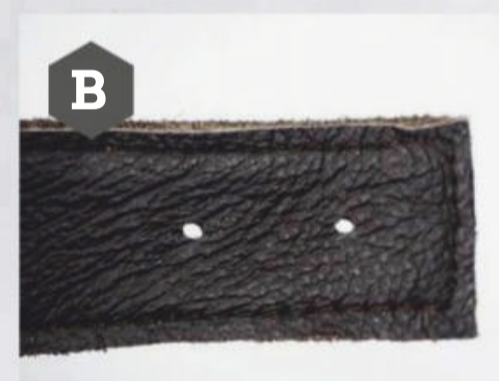

PREPARE THE SLIP POCKETS

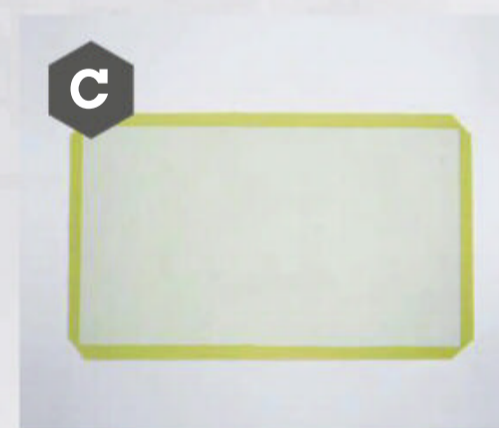

MAKE THE LINING

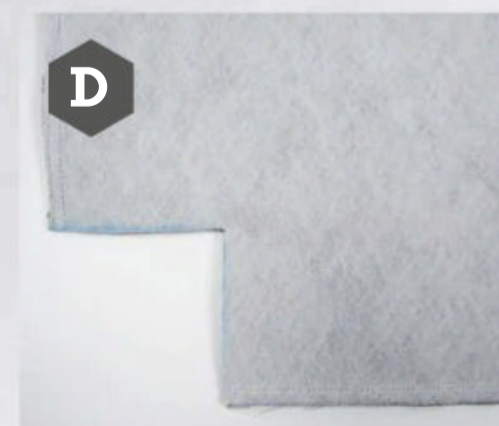

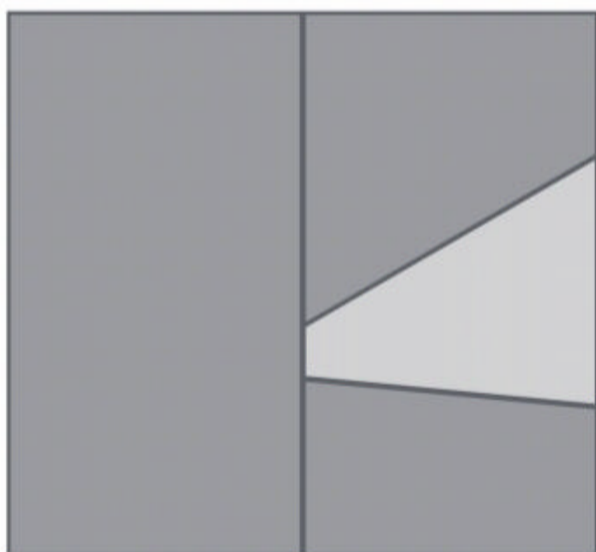
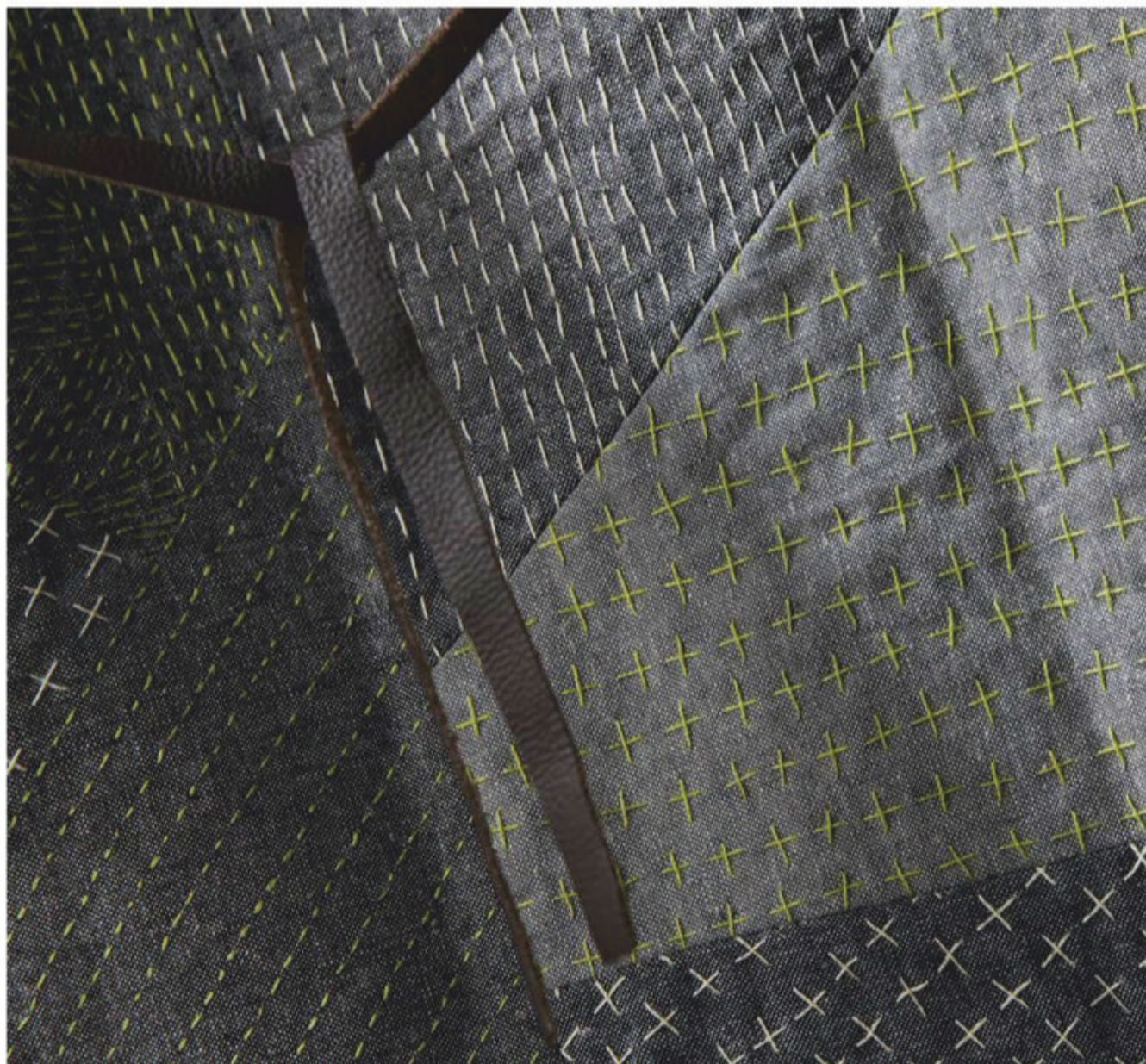

Fig 2

TOP TIPS

- You can make the handles as long or as short as you would like. Be aware though that if you make them longer, you may need more leather than the specified amount. The leather can be joined if you need to. Cut the ends on the diagonal to do this and keep the joins away from one another.
- The stitch patterns are all based on straight lines with crosses and dashes going in various directions. Use a ruler and water soluble marker to mark the embroidery lines about 1/4in – 1/2in apart. Mix up the patterns a bit to add great texture.

17 Topstitch along the sides and bottom of the slip pocket, backstitching at each end and pivoting at the corners. Make sure to stitch approx 1/8in from the edge, closing the turning gap as you stitch the pocket in place.

18 Repeat steps 16–17 to stitch the second slip pocket to the other lining panel.

19 Place the two lining panels right sides together, carefully aligning at the top. Sew along the sides and bottom, leaving a turning gap in the bottom and backstitching at the start and end of each seam.

20 Cut a 2 1/2in square in each of the lower corners (Fig D). Working one corner at a time, bring the side and bottom seams together and sew the corner, backstitching at each end. Repeat for the other corner.

MAKE THE OUTER

21 Join your embroidered Template 1, 2 and 3 pieces into one column, pressing the seams open. Trim to 13 1/4in x 25in. Then join the embroidered 13 1/4in x 25in piece to one side to complete the front panel (Fig 2).

22 Fuse the batting to each of your front and rear panels, referring to the manufacturer's instructions. Place the

leather ties at either side of your front panel, approx 1/2in from the top edge, and baste in place.

23 Place the front and back panels RS together, making sure the long ties are tucked between the layers, out of the way. Sew around the sides and bottom. Repeat step 20 to box the corners.

FINISH THE BAG

24 Turn the outer RS out. Place inside the lining so they are RS together. Carefully match the seams at each side and pin or clip around the top edge.

25 Sew around the top edge. Turn the bag RS out through the gap in the lining. Stitch the lining gap closed and push down inside the bag. Press around the top edge and topstitch.

26 Measure and mark 7 3/4in from each side, on both the front and back of the bag. Place one end of the handles at each mark and install using the rivets to finish.



Debbie von Grabler-Crozier

Debbie's two loves are craft and quantum physics!

➔ sallyandcraftyvamp.blogspot.co.uk

📷 [craftyvamp](https://www.instagram.com/craftyvamp)

SASHIKO SHOPPER

Template 1

ENLARGE 200%

TEMPLATE 2 EDGE

DOWNLOAD AND PRINT
FULL-SIZE TEMPLATES
WWW.GATHERED.HOW/
LOVEQUILTINGMAG

ANDRA BLOCK

BLOMMA

BLOCK
2 of 12

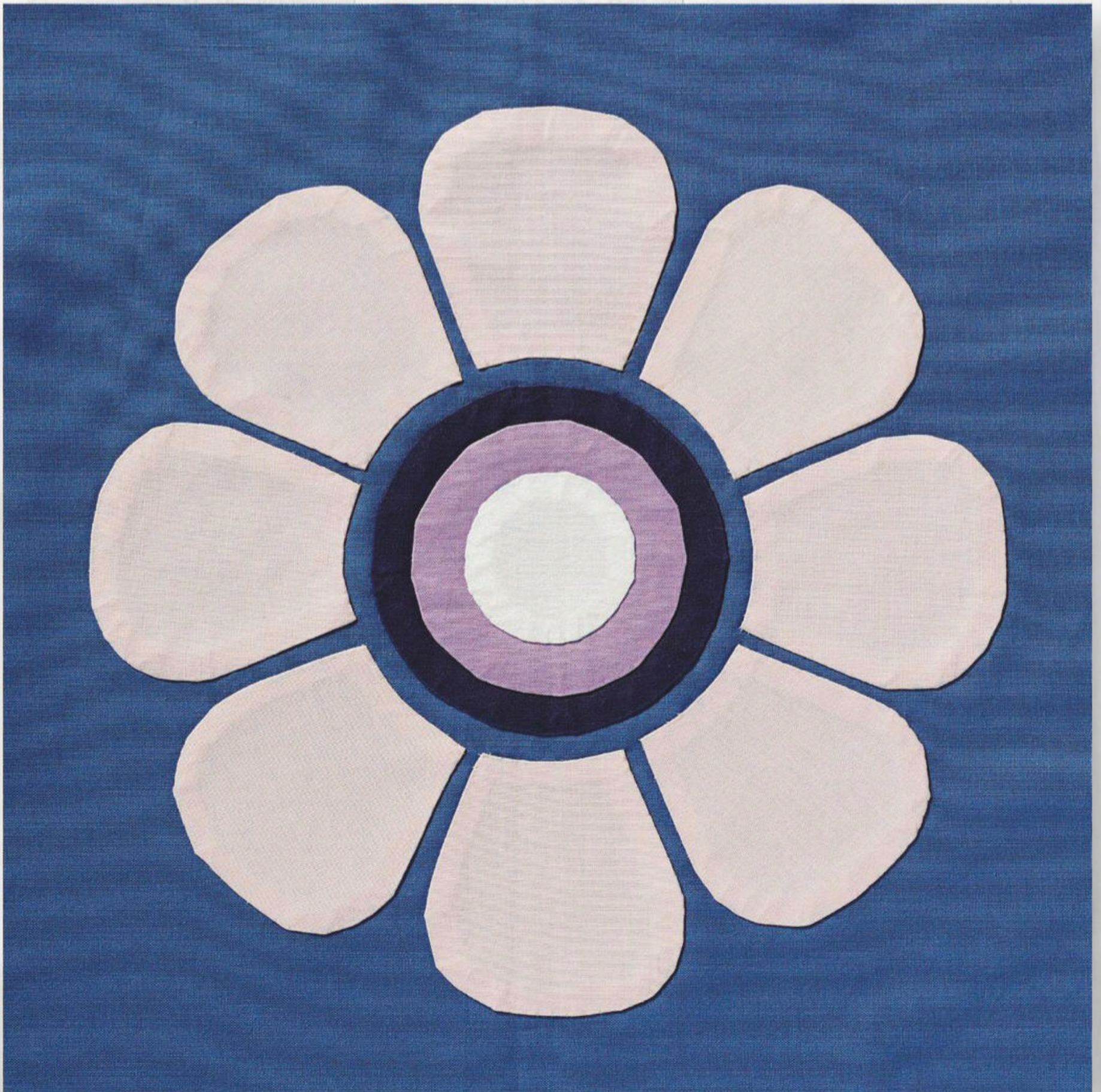

By Yasmeen K Branton

YOU WILL NEED

To make Block 1:

- Dark blue fabric: 13in square
- Peach fabric: 8in x 16in
- Mid purple fabric: 5in square
- Dark purple fabric: 4in square
- White fabric: 3½in square
- One (1) copy each of the Andra block Petal, Small, Medium and Large Circle templates

To make Block 2:

- Light blue fabric: 13in square
- Navy fabric: 8in x 16in
- Dark purple fabric: 5in square
- White fabric: 4in square
- Mid purple fabric: 3½in square

FINISHED SIZE

- Quilt: 60in x 72in
- Block 12½in square (unfinished)

TO MAKE THE WHOLE QUILT:

- White fabric: 1½yds
- Peach fabric: 1¼yd
- Mid purple fabric: 1½yds
- Dark purple fabric: ¾yd
- Navy fabric: 1½yds
- Dark blue fabric: 1¼yds
- Light blue fabric: 2yds
- Light green fabric: ¾yd
- Mid green fabric: 1yd
- Backing fabric: 5½yds
- Batting: 70in x 82in
- Binding fabric: 5/8yd

Take yourself to our website gathered.how/lovequiltingmag to see the full quilt Layout Diagram

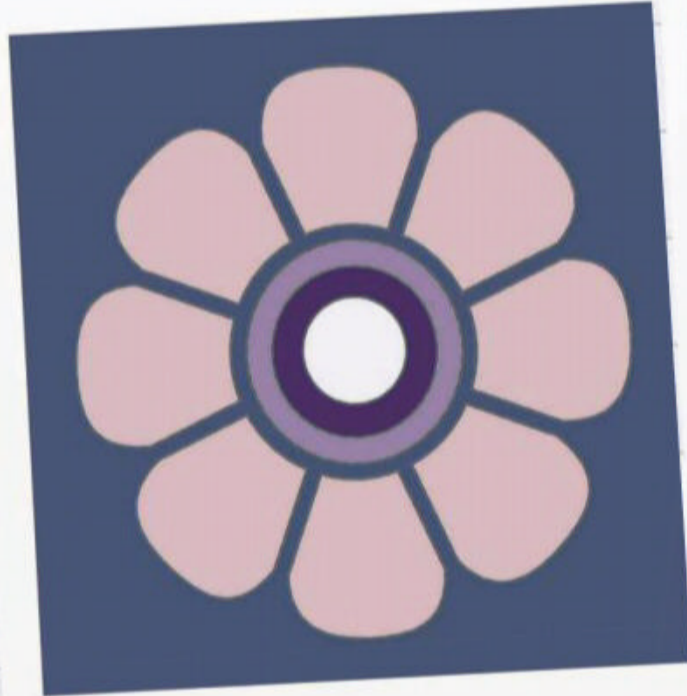

BLOCK 1 LAYOUT DIAGRAM

If you're struggling to get a smooth curve, use a running stitch to gather the fabric around the paper template

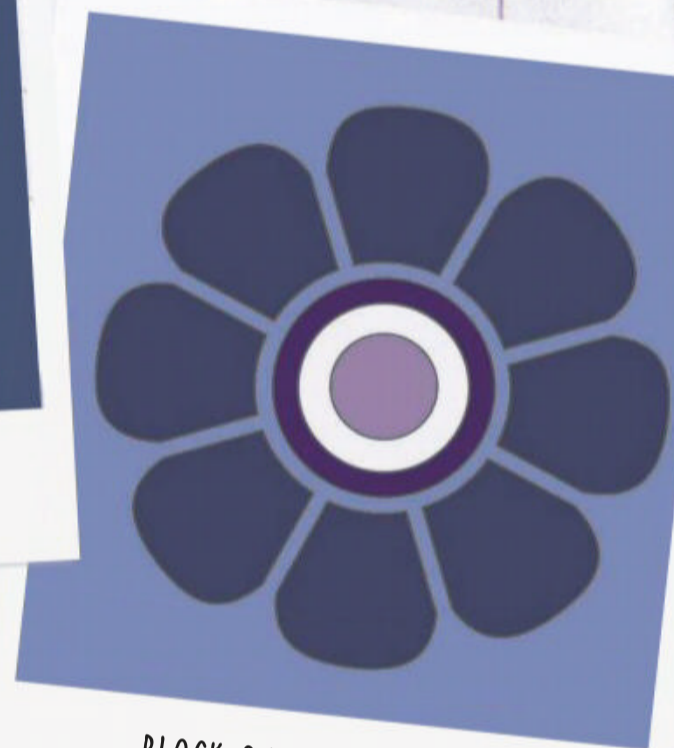

BLOCK 2 LAYOUT DIAGRAM

NOTES

- Seam allowances are ¼in.
- Templates do not include seam allowance.
- If you precut all your background squares at the start of the quilt, disregard steps 1 and 4.
- For a guide to appliqué, see gathered.how/applique.

FABRICS USED

All fabrics are Kona Cotton Solids by Robert Kaufman in Snow, Dusty Peach, Lupine, Hibiscus, Nautical, Cadet, Dresden Blue, Seafoam and Sage.

CUTTING OUT - BLOCK 1

- 1 From the dark blue fabric cut:
 - One (1) 13in square for the background.
- 2 Cut out each of the template pieces and trace around them on the fabric using a chalk marker, on the right side of the fabric. Refer to the Block 1 Layout Diagram above for the colours of each piece. Make sure to leave space between pieces big enough

to add a seam allowance around the edges of each one.

- 3 Cut out each piece, adding a scant ¼in seam allowance all the way around the edges.

CUTTING OUT - BLOCK 2

- 4 From the light blue fabric cut:
 - One (1) 13in square for the background.

- 5 Repeat steps 2–3, referring to the Block 2 Layout Diagram.

PIECING THE BLOCK

- 6 Mark the centre of the square, both horizontally and vertically. Then mark both diagonals. Yasmeen used a Hera marker, and then went over the marks with basting stitches, making them easier to see (Fig A).
- 7 Take the largest central circle and place the template back on top. Mark the points on the template within the seam allowance of the circle. Use the marks to align in the centre of the

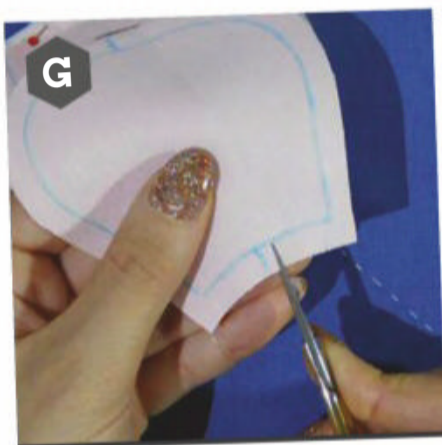
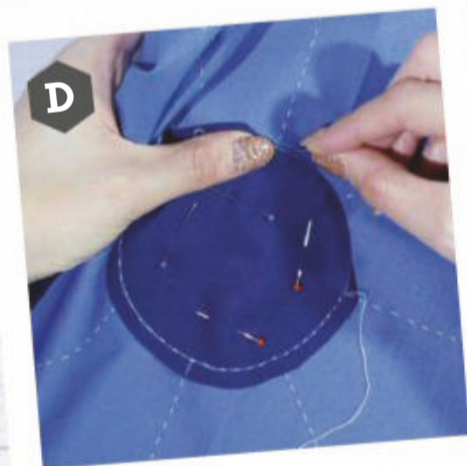
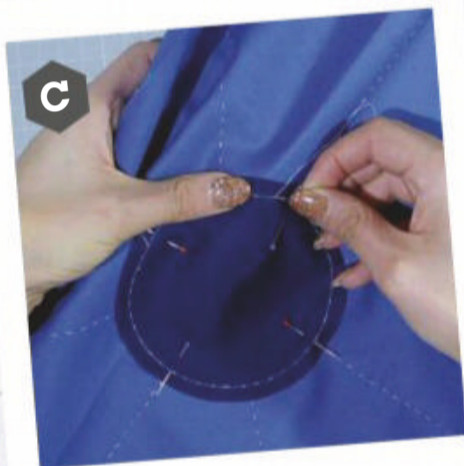
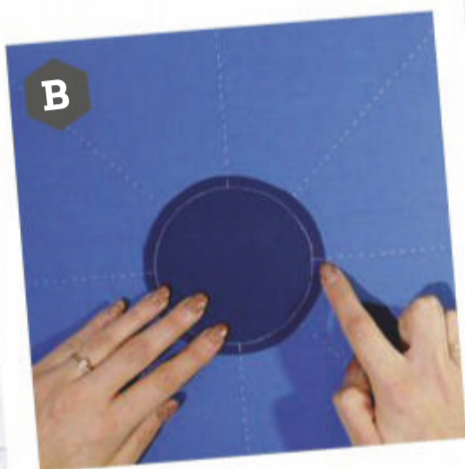
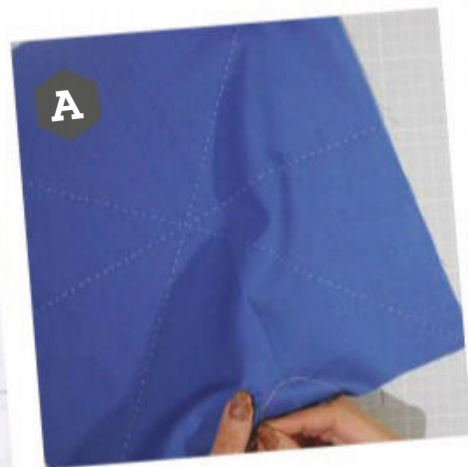

background square (Fig B).
Pin, then baste in place (Fig C).

8 Once the circle is in place, using matching thread, unpick your basting stitch as you turn under your seam allowance. Stitch the circle in place all the way around the edge (Fig D).

9 Repeat steps 7–8 to add the medium and then small circle to the centre (Figs E–F).

10 Mark the central line for each flower petal within the seam allowance, using the template as a guide. Clip the bottom curved edge within the seam allowance (Fig G). Finger press this bottom edge under.

11 Mark $\frac{1}{4}$ in from the large circle along each of the marked lines on your background square (Fig H). Arrange the folded edge of each petal with the marks and pin in place (Fig I).

12 Once all petals are arranged around the circle, baste in place (Fig J). Stitch each petal into position, as in step 8.

13 Remove any remaining basting stitches from the background fabric. Lightly starch and press the block. Carefully centre the block and trim to $12\frac{1}{2}$ in square to finish.



Yasmeen K Branton

Yasmeen is a hand appliqué designer who transfers the skills she developed studying hand embroidery at the Royal School of Needlework to modern sewing patterns.

Slow stitching acts as her daily meditation, and she couldn't go a day without it!

➔ sandandstars.co.uk
 [sand.and.stars](https://www.instagram.com/sand.and.stars)

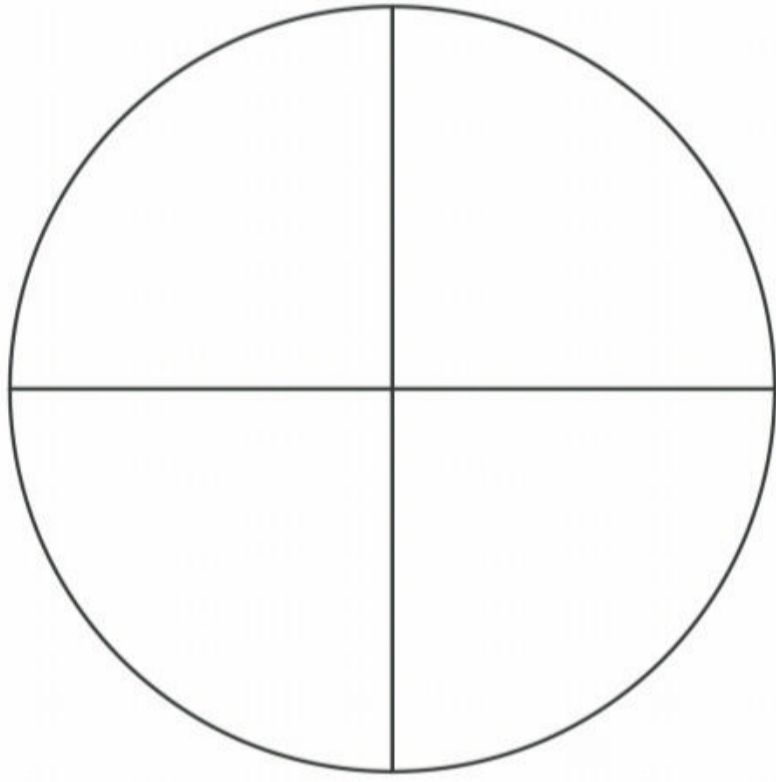

BLOMMA
Andra Medium Circle template
ACTUAL SIZE

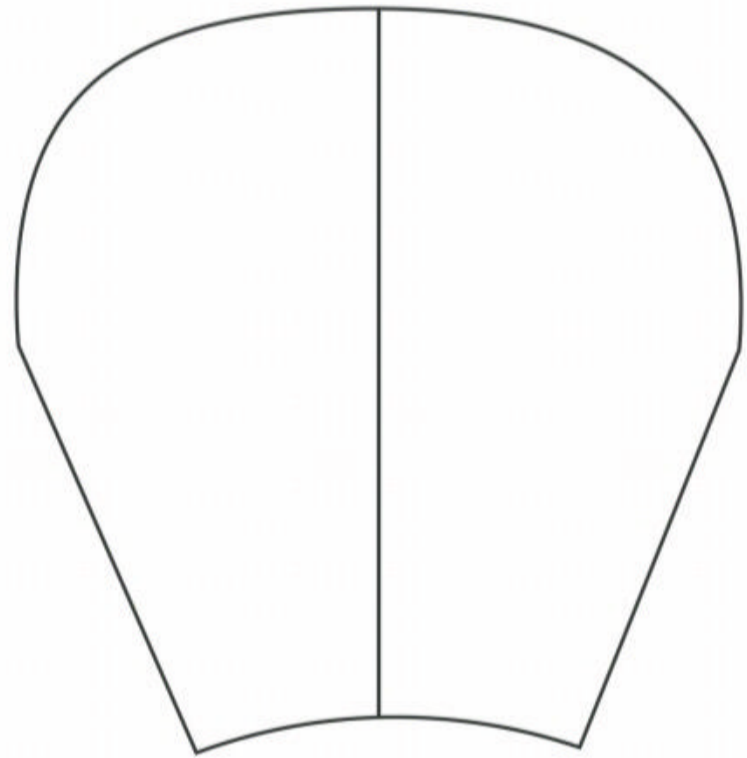

BLOMMA
Andra Petal template
ACTUAL SIZE

BLOMMA
Andra Large Circle template
ACTUAL SIZE

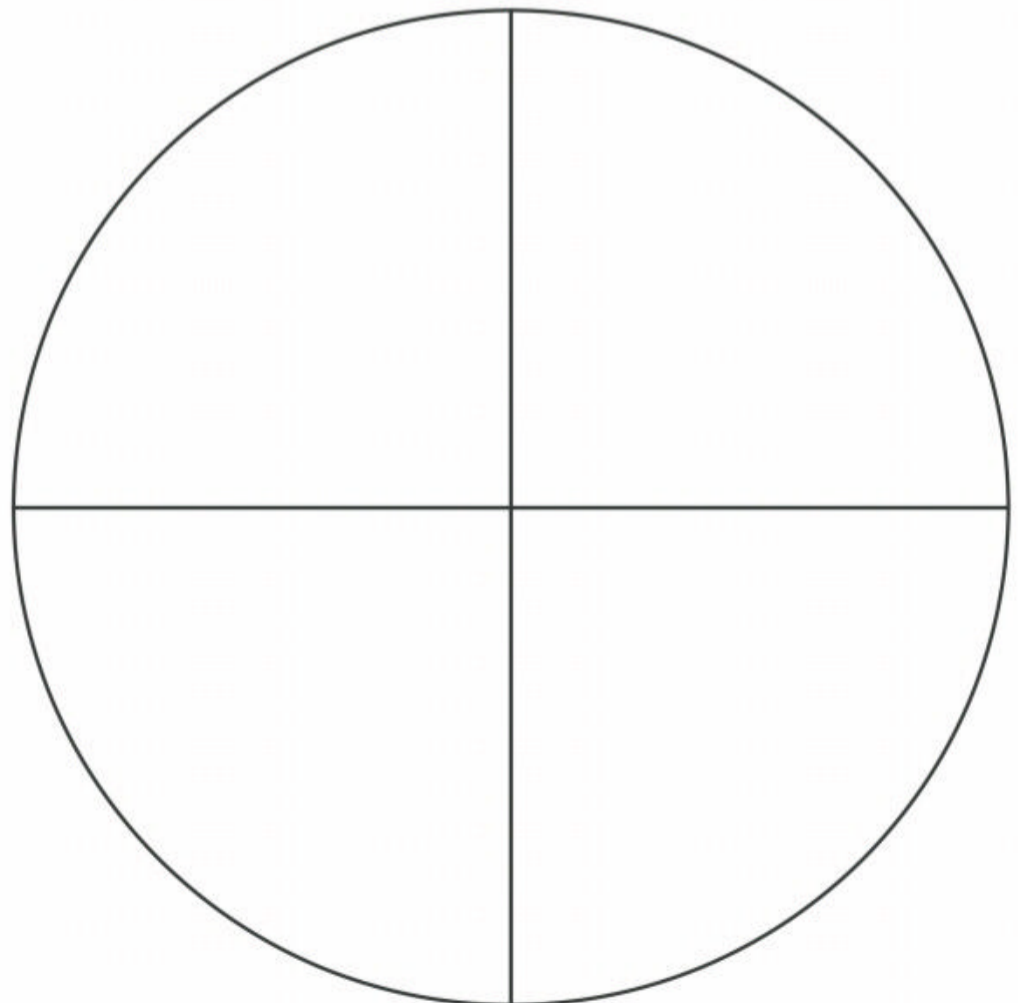

BLOMMA
Andra Small Circle template
ACTUAL SIZE

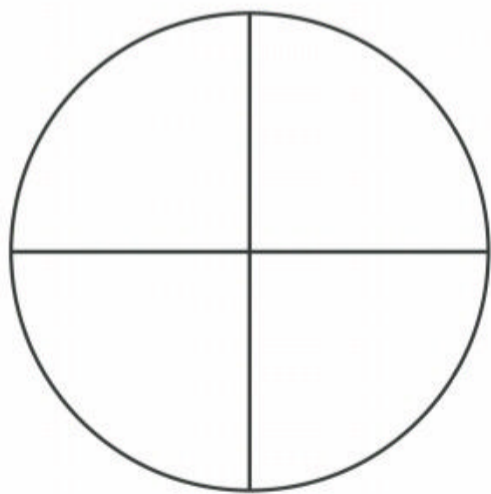

NEXT ISSUE

Issue 88 on sale
5 August 2020

MAKE IT...

Candy coloured HSTs by Alli Jensen
Fruity FPP blocks by Jo Hart
Cute cat prints by Art Gallery Fabrics
Abstract cushions by Sophie Zaugg
Sweet star design by Elisabeth DeMoo
PLUS Star-shaped pin wheel
in exclusive colours!*

* Print copies only. Gift subject to change.

5 WAYS TO:

Scratch a quick sewing itch

Short on time? Luckily **Amanda Carye's** not short on ideas for speedy sewing sessions...

Some days you want to push the proverbial boulder just a little bit more on a long-term project. And other days you just want to sit down and sew something from start to finish there and then. For those times when you're looking for a little instant gratification, here are five of my current go-to sewing projects that are the perfect combo... quick and easy:

1 5-MINUTE MAKE

Got a couple of 4½in square scraps left over from a project? Take two and sew a ¼in seam around the edges right sides together, leaving a gap on one side to turn them right side out. Grab some stuffing to turn them into a pin cushion (always handy) or some potpourri or lavender for sachets.

2 20-MINUTE STITCH

Scrunchies are back. Cut a 3½in x 25in piece of fabric, sew right sides together along the long edge then turn the tube inside out. Safety pin a 9in piece of ¼in elastic to one end of the tube, thread it through (scrunching the fabric as you go) and tie into a knot. Fold the raw edge of one end under and tuck the other raw-edge into the folded end. Stitch ends together, wear with attitude.

3 HALF-HOUR PROJECT

If you have a yard or so of lightweight fabric you can't bear to cut into, make a neckerchief! Trim your fabric down to 36in square. Pick another fabric to make the binding (I like a good pop of colour for contrast, but you do you). Four 2in WOF strips should do the trick, but go narrower if you want a dainty edge, or wider if you want a bold one. Sew the binding to the square, as you would a quilt. Instant fashion statement!

4 IN AN HOUR

Grab a neutral fabric and some bright contrasting thread and quilt a grid to make a new pillow cover or two (or ten)! Play around with your grids. Maybe make a simple one-line window pane design, a basket weave or a cool plaid with your threads. The sky is the limit!

5 HALF-DAY IDEAS

Got a little more time (like a slow and lazy Saturday afternoon)? Make a scrappy quilt clutch/computer case/makeup bag. Dive into your scrap bin and make a simple block for the front panel (I typically stick to rectangles, but if you're feeling ambitious, why not try some improv curves?). Quilt it, trim it down to size, attach a chunky zipper, sew up the sides and presto: a new bag!



broadclothstudio.com

[broadclothstudio](https://www.instagram.com/broadclothstudio)

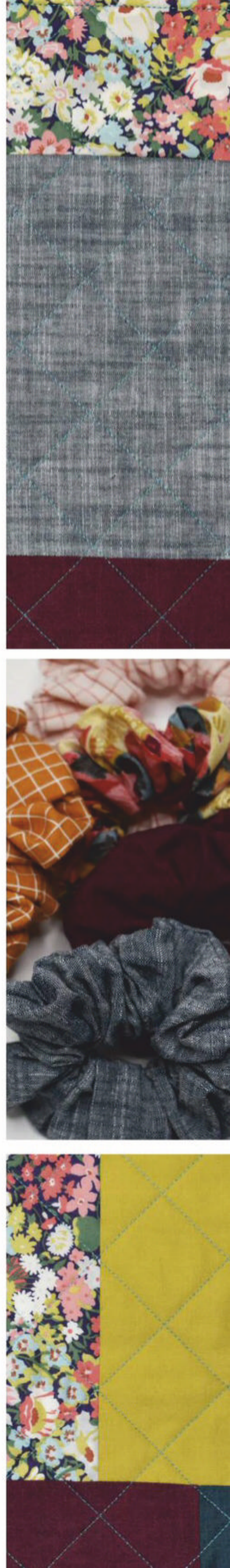

MADE WITH LOVE

The Ultimate Guide to QUILTING

PATCHWORK BEYOND THE BASICS



INSPIRING QUILT PATTERNS

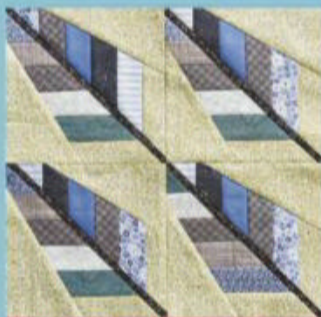

PRO PIECING METHODS



EXPERT STEP-BY-STEPS



ADVANCED TIPS & TECHNIQUES

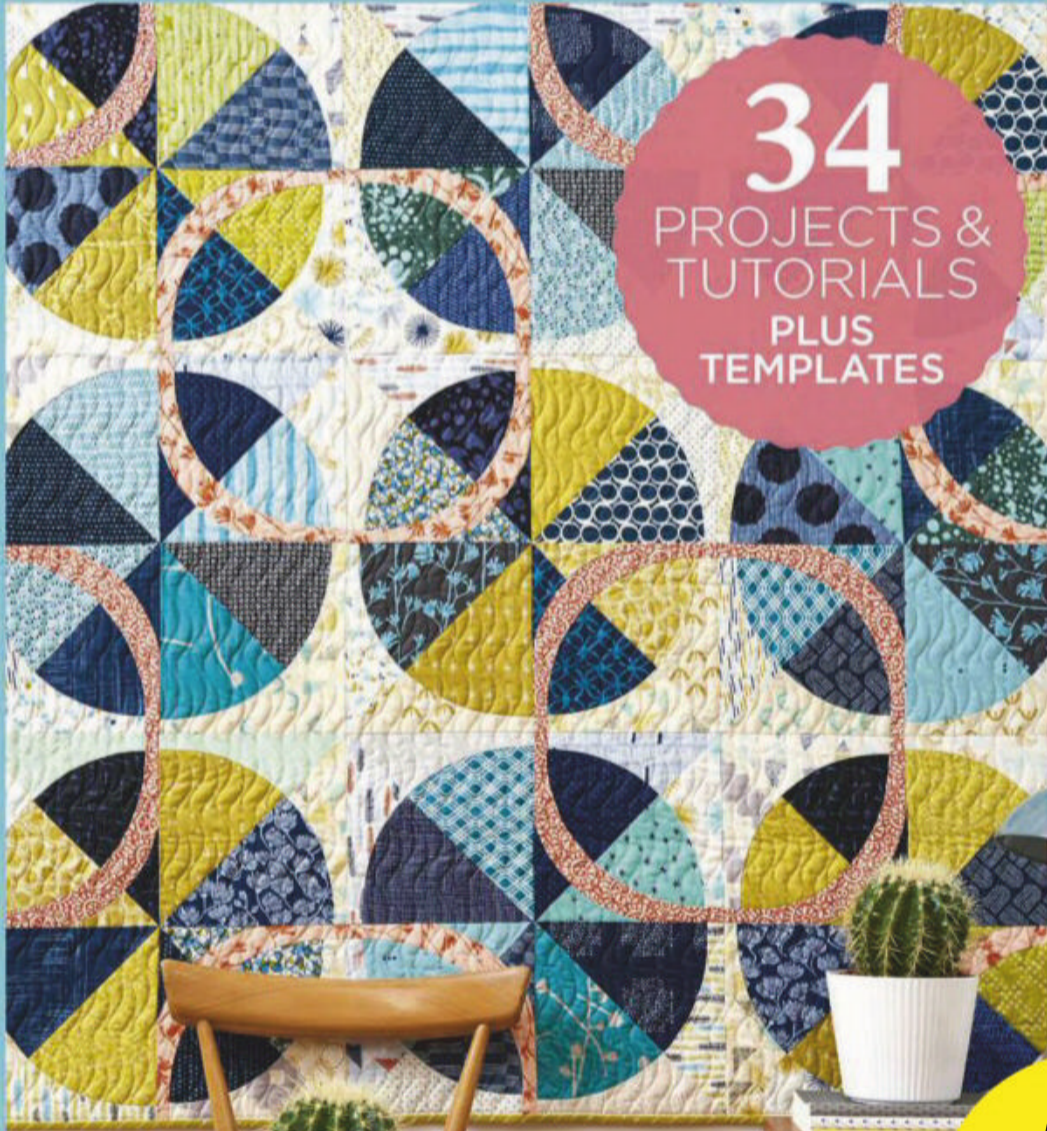

34 PROJECTS & TUTORIALS PLUS TEMPLATES

JUST £9.99!*

CLASSIC CRAFT SPECIAL SERIES



Boost your patchwork and quilting skills with 34 step-by-step tutorials and projects!

ORDER ONLINE
www.buysubscriptions.com/ultimatequilting
or call 03330 162 138[†]

AND QUOTE 'THE ULTIMATE GUIDE TO QUILTING PRINT 1'

*UK calls will cost the same as other standard fixed line numbers (starting 01 or 02) and are included as part of any inclusive or free minutes allowances (if offered by your phone tariff). Outside of free call packages call charges from mobile phones will cost between 3p and 55p per minute. Lines are open Mon - Fri 8am-6pm and Saturday 9am-1pm for orders only. Overseas please call +44 (0)1604 973 746. Price applies to UK orders only. EUR price €11.99, ROW price €12.99. All prices include P&P. Please allow up to 28 days for delivery.

INNOV-IS XP1

Sewing, quilting and embroidery machine

- Superior embroidery frame 272 x 408mm (10.7 x 16") - Our largest embroidery area
- Super long arm 13.1" (332mm) workspace
- Camera detecting buttonhole function
- Over 1,100 built-in embroidery designs
- Revolutionary built-in projector
- My Design Centre
- Includes 5 Year warranty



£10,999

+ FREE
Upgrade kit &
Luggage set
worth
£799.99

INNOV-IS V3

Embroidery machine

- Large 300mm x 180mm embroidery area - ideal for larger projects
- Large LCD touch screen - including on-screen editing for embroidery projects
- Thread sensors, auto tensioning and easy threading for easy use and a professional finish
- Over 200 built-in embroidery designs
- Full spectrum LED lighting
- Automatic thread cutting



£1,999

+ FREE
Upgrade kit 1
& LED pointer
& embroidery foot
worth
£297.98

INNOV-IS F420

Sewing machine

- 140 stitches, including 10 buttonhole styles
- 5 Styles of lettering (uppercase)
- Advanced one action needle threader
- SFDS: Square Feed Drive System
- Lock stitch button
- Knee lift
- Memory function
- User-friendly LCD screen



£599

+ FREE
Creative Quilt
Kit worth
£149.99

INNOV-IS A80

Sewing machine

- 80 stitches
- Automatic 1 step button hole 5 styles
- Advanced one action needle threader
- Stitch length and width control
- Start/Stop button and slide speed control
- Lock stitch button
- Quick set bobbin



£449

+ FREE
Creative Quilting
kit worth
£149.99

Scotland

David Drummond Edinburgh EH12 5HD 0131 313 1002
The Sewing Machine Shop No.29 Fochabers IV32 7DU 01343 823961
Karelia House Ltd By Aberfeldy PH15 2LS 01887 822 027
Pembertons Sewing Machines Stirling FK8 1HA 01786 462 993
Aberdeen Sewing Machines Ltd Aberdeen, AB25 1UR 01224 478555

North East

Sewing Machine Sales Whitley Bay NE26 2SY 0191 2525 825
Tullys Sewing Machines Sunderland SR1 3JG 0191 565 7995

North West

Bamber Sewing Machines Ltd Eccles M30 7HY 0161 707 7786
Hobkirk's Sewing Machines Ltd Blackburn BB2 2AJ 01254 693 555
Jaycotts Sewing Machines Chester CH1 4LT 01244 394 099
Lord's Sew Knit Centre Accrington BB5 3DE 01254 389 171
M&S Sewing Machines Heywood OL10 4NN 01706 366 943
R&T Machines Blackburn BB1 2AL 01254 520 63
Temptations Bentham LA2 7HQ 01524 261 868
Fabrics at Fleetwood Fleetwood FY7 6DU 01253 870 470
Cumbria Sewing and Craft Barrow-in-furness LA14 1PU 01229 823714
Etty Lilly Bolton Le Sands LA5 8DB 01524 734 713
Weaverdee Middlewich CW10 0GF 01603 339818
Superior Sewing Centre Carlisle CA3 8PW 01228 599880
Bizzie Fingers Lytham St Annes FY8 1SZ 01257 721 721

Yorkshire & The Humber

A61 Woodseats Sewing Machines Ltd Sheffield S18 2GF 0114 255 2822
Sewing Machines and Crafts Keighley BD21 1AD 01535 609466
Fabric Mouse Richmond DL10 7SN 01748 811593
School of Sew Leeds LS28 5UJ 0113 4182718
Stocks Sewing Machine Ltd Leeds LS119RT 0113 242 9378
Singer Sewing Centre Wakefield WF1 1QE 01924 374471
Sewing Centre Barnsley S70 1SZ 01226 248230
The Fabbadashery Halifax HX1 2HX 01422 647574

Midlands

Brewers Sewing Machines Wolverhampton WV2 3AF 01902 458 885
Couling Sewing Machines Lincoln LN5 8AN 01522 521 841
DC Nutt Sewing Machines Walsall WS3 3SS 01922 497 603
Grain Sewing Machines Ltd Nottingham NG6 8UY 0115 927 1155
Frank Nutt Sewing Machines Birmingham B14 7AA 0121 444 3978
GS UK Ltd Nottingham NG2 3DE 0115 844 8000
Sewing Machine Centre Shrewsbury SY1 1XJ 01743 343 902
The Lorna Knight Sewing Academy Leek ST13 7NX 01538 371 682
L & M Nutt Sutton Coldfield B73 5BS 0121 373 5497
Leicestershire Craft Centre Market Harborough LE16 7NJ 01858 466692
Refresh Sewing Leominster HR6 8BT 01568 610044

East Anglia

Bedford Sew & Knit Limited Bedford MK41 7LE 01234 217 096
Franklins Group Limited Colchester CO2 7DU 01206 563 955
Franklins Group Limited Ipswich IP1 3EL 01473 221 188
Franklins Group Limited Chelmsford CM2 0LG 01245 346 300
Sewing Machine World Kings Lynn PE30 5DD 01553 773 362
Stitch X Stitch Stowmarket IP14 1HH 01449 257070
Backstitch Cambridge CB23 7EY 01223 778118

Wales

Cliffords Sewing Machines Swansea SA1 3JY 01792 655 928
J&B Sewing Machine Co Ltd Newport NP19 4SY 01633 284 646
J&B Sewing Machine Co Ltd Cardiff CF11 8AA 02920 402 418
Sewing Machines Direct Wrexham LL12 0PJ 0800 622 6224
Sewing Innovations Techsoft UK Ltd Bodelwyddan LL18 5TQ 01745 586845

South East

Bobbin Along Worthing BN11 3EG 01903 200 771
Dowlings Sewing Machines Wickford SS11 8YJ 01268 570248
GTS Sewing Machines Banbury OX16 9PQ 01295 701384
Hastings Sewing Centre Hastings TN34 1RE 01424 420 108
Lewisham & Deptford Sewing Machines Ltd London SE8 3NT 0208 692 1077
Maidstone Sewing Centre Maidstone ME14 1ED 01622 670 254
Home of Sewing by Regent Ilford IG1 2AG 0208 4780 669
Rona Sewing Machines Waltham Cross EN8 7AP 01992 640 250
Sew Devine Reading RG6 1JQ 0118 926 8664
The Sewing Centre London SW11 3BP 0207 228 0036
Sewing & Craft Superstore London SW17 7AA 020 8767 4724
The World of Sewing Tunbridge Wells TN1 2QP 01892 533 188
The World of Sewing Orpington BR6 75Q 01689 638 638
Tysew Southall UB1 3AF 0208 574 1750
Sueco UK Portsmouth PO3 5BZ 02392 697621
Stitched By You Alton GU34 1BN 01420 544033
Sew Creative Petersfield GU32 3EW 01730 858020

South West

Caffle Crafts Weston Super Mare BS24 6SE 01934 838 327
Exeter Sewing Machine Company Exeter EX1 2LD 01392 275 660
Franklins Group Limited Salisbury SP2 7SU 01722 554 466
The Sewing Studio Redruth TR15 2DB 01209 216 942
White Orchid Corfe Mullen BH21 3UX 01202 886 001
Threads Minehead TA24 5BT 01643 708372

Northern Ireland

Sew N Knit Belfast BT14 1AB 028 9045 6012

Offers valid from 1st June
to 31st July 2020



brothersewing.co.uk

For full details visit your www.brothersewing.co.uk or visit your local Brother stockist.

THE QUILTING

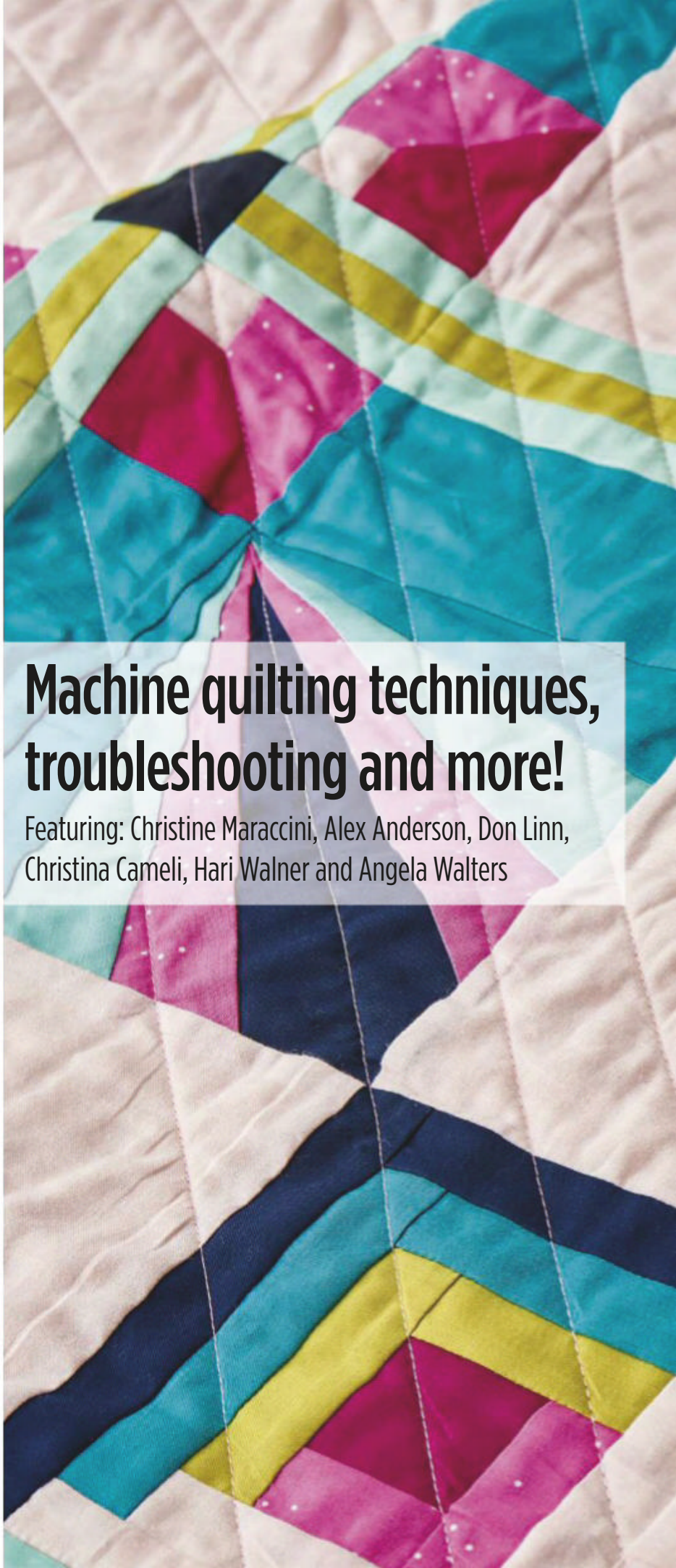

Machine quilting techniques, troubleshooting and more!

Featuring: Christine Maraccini, Alex Anderson, Don Linn,
Christina Cameli, Hari Walner and Angela Walters

BEST-SELLING BOOKS *in Quilting*

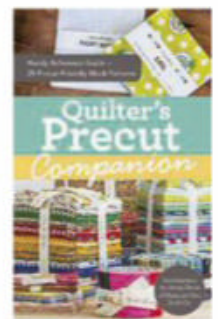

Available from Search Press.

Please go to Searchpress.com for details,

email: sales@searchpress.com, or call at Tel: 01892 510850



Meet our contributors!

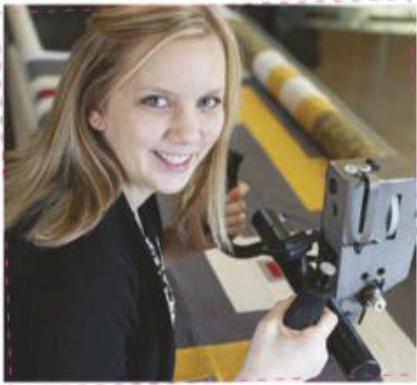

Angela Walters

Angela loves teaching others to use quilting to bring out the best in their quilts. See her work in many magazines and books. quiltingismytherapy.com



Alex Anderson

Alex is a host of the TV show *Simply Quilts*, as well as an executive producer and cohost of *The Quilt Show* with Ricky Tims. alexandersonquilts.com

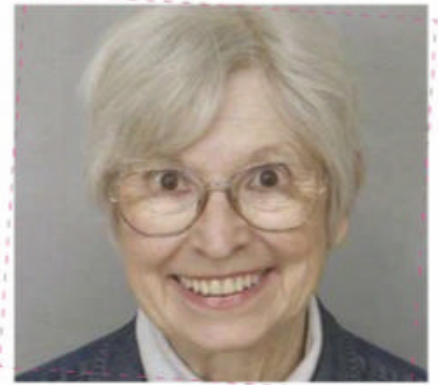

Hari Walner

Hari has been teaching quilting since the 90s, with an emphasis on free-motion machine quilting, trapunto effects and the creative use of threads



Don Linn

Don started his journey in quilting with a longarm machine and not a clue how to operate it. He is now a well-known teacher of piecing and machine quilting



Christina Cameli

Christina is a nurse, midwife and quilter who enjoys finishing quilts on her domestic machine and teaching free-motion classes for beginners. christinacameli.com



Christine Maraccini

Christine first began her machine-quilting business in 2000. Since then she has received various awards for her work. christinescustomquilts.weebly.com

Meet the team

Editor Alice Hadley
Art Editor Kit Cheung
Operations Editor Lorna Slessor
Senior Technical Editor
Sarah Griffiths
Senior Digital Editor Zoe Williams

Contact us

Love Patchwork & Quilting,
Immediate Media,
Eagle House,
Colston Avenue,
Bristol, BS1 4ST, UK
lovequilting@immediate.co.uk

Content used with permission from our friends at C&T Publishing. Originally featured in *The Quilting Manual: Techniques, Troubleshooting & More*. To purchase visit ctpub.com

THE BASICS OF MACHINE QUILTING

How to organise your work space and machine quilting tips from **Christine Maraccini**

Throughout my quilting career I have quilted on both a domestic (tabletop) and a longarm machine. I'd like to take a moment to debunk the popular myth that a longarm machine is a magical tool that produces amazing quilting. A longarm quilting machine does make machine quilting more convenient and efficient. However, it is not necessary to

use a longarm machine to achieve beautiful quilting. The majority of machine quilting patterns can be done on either a domestic or a longarm machine. The quality of the quilting is dependent on you and your ability to freehand draw the designs that you choose to quilt, not on the technology of the machine that you are using.

Free-motion quilting on a domestic machine

Each brand of machine has its own quilting feet – I prefer the type with a clear ring or oval



Quilting feet

For free-motion quilting, you will need a free-motion or darning foot for your machine. My favourite ones have a clear ring or oval that presses against the fabric as you sew.

These are great because they enable you to see where you are going. Usually the circle on the bottom of the foot has a relatively accurate radius measurement of $\frac{1}{4}$ in, which can come in handy as a spacer when you are echo quilting. Each brand of sewing machine has specific feet that will fit on it. See your local sewing machine dealer to get the correct foot for your personal machine.

Your working style and space

One of the biggest complaints about machine quilting is the difficulty of manoeuvring a large quilt under the short arm of a domestic sewing machine. My working style is to quilt in continuous paths whenever possible. This enables me to roll the quilt so that just the path I need is exposed. I can start at one end of the quilt and sew one design, non-stop, until I reach the other end of the quilt. I hate to start and stop, so I try to do it as little as possible. Remember, our goal is to get these quilts finished!

Your workstation must have a flat surface behind and to the left of your sewing machine large enough to hold the weight of your entire quilt as you sew. I quilt at my kitchen table with my sewing machine located at the front right corner of the table. When I have an

especially large quilt, I add another table to the back of my kitchen table to increase the surface area.

I also like to use an extended base on my sewing machine when I'm quilting. This extra surface allows me to maintain better control over the area I'm quilting.

TOP TIP

If your quilt seems to be sticking to the extended base, wipe the base with a small amount of furniture polish and the surface will become slicker. As you would after contact with any chemical, be sure to wash your quilt when completed to remove any residue.

Your workstation can be simple or fancy. I prefer simple, so a large table and a machine with an extended base are perfect

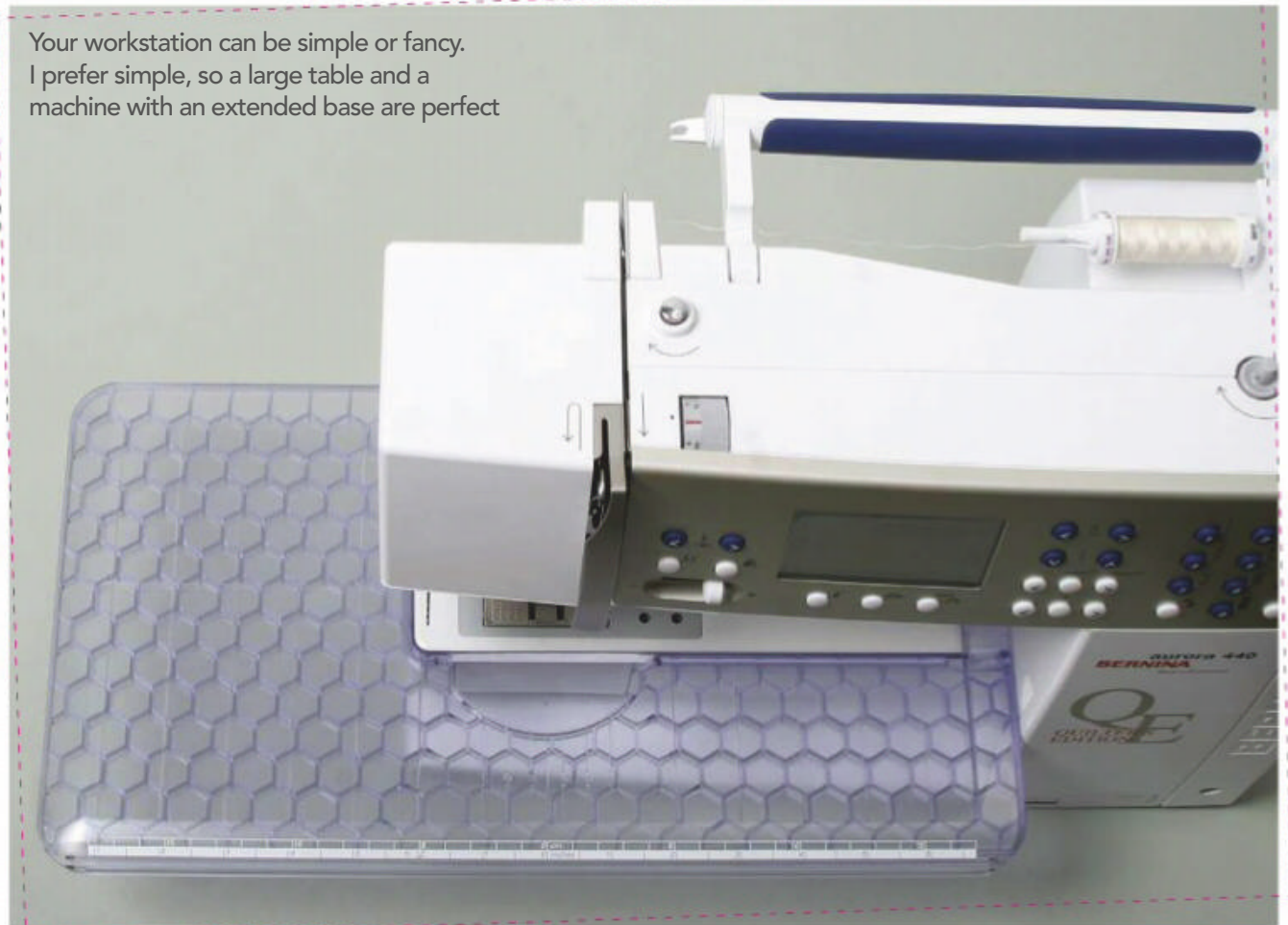

MACHINE QUILTING: A GUIDE

Free-motion quilting on a longarm machine

The most commonly used longarm machines in the industry have the following things in common – a large throat, long canvas leaders to pin your quilt layers to and a smooth carriage system to move the machine while you sew. I prefer to “float” my quilt tops on my longarm machine. This means that I pin the backing fabric onto the leaders. I then lay the layer of batting onto the backing near the top leader and then lay the quilt top onto the batting. I pin the quilt top through the batting and onto the backing. I allow the quilt top to drape over the front edge of the machine and this allows me to adjust the quilt top as I work. I can fix any spots that are uneven or have extra fullness as I move down the quilt. The most important thing I can tell you about using a longarm machine is that it takes practice. These are not magic

machines. The general rule is that it takes one full year to become comfortable and proficient on a longarm – you will get better each time you finish a quilt. Ask your local quilt guild if they have charity quilt tops that need to be quilted.

This is a great opportunity to get in some extra practice. Also, take lessons from experienced teachers who are familiar with the brand of machine you use. Be sure to take a maintenance class for your machine as well. Take time to learn how your machine operates in the specific climate and conditions that it is in. Given that a longarm has so many moving parts and tension dials, you do need to practise and experience how your machine works in order to get the most from this wonderful piece of equipment.

Burying threads

How to start and stop, that is the question! I’m not happy if my starts and stops are visible. In fact, most quilt show judges are not happy to see these either. Whether on a longarm or a domestic machine, I use a method that involves what I’ve been told is a hand-quilting knot.

Always start quilting in a spot that’s easy to hide, such as a seam or the base of a leaf or flower. When starting, I drop the needle and raise it so that I can pull the bobbin thread to the top of the quilt (right).

I hang onto the two tails (bobbin and needle threads),



then drop the needle back into the exact same hole that I pulled the bobbin thread through earlier. Hang on tight to the tails so that you don't get a nest of thread on the back of your quilt! Start sewing from that point. Once you have laid down a few inches of stitching, it's safe to let go of the tails and tie them off. Tie a square knot (left over right, then right over left), landing the knot exactly over the hole that your stitching started at (top right). Pop both of the threads through a self-threading needle.

Slide this self-threading needle under the top layer of your quilt, starting at the hole where you began sewing, and proceed in the direction of your quilting (bottom right). Pull the needle out an inch or two away from where you began. Give the needle a little tug and the square knot will pop into the hole where you began sewing. Clip these threads close to the top of the quilt.

When you run out of thread in your bobbin or spool, or stop quilting, use the same process. If you don't have long enough tails of thread, unpick your stitches back to a suitable junction, and then pull the bobbin thread to the top and continue from there.



TENSION AND HAND PLACEMENT

Correct tension and hand placement are key to good quilting, says **Don Linn**

Test your tension

It is very important to have proper tension when machine quilting. If the bobbin thread tension is too loose or the top thread tension is too tight, the bobbin thread will tend to be pulled to the top of the quilt, and the top thread will lie flat against the quilt top. Conversely, if the bobbin tension is too tight or the top thread tension is too loose, the bobbin thread will lie flat against the back of the quilt, and the top thread will be pulled to the bottom.

Threads are made from different materials and come in different diameters. These variables affect how the thread flows off the bobbin, and this ultimately has an effect on tension and stitch quality.

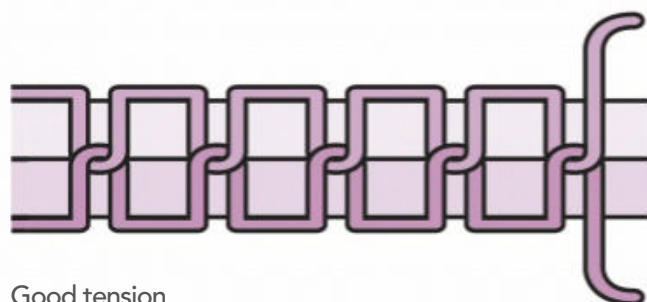

Good tension

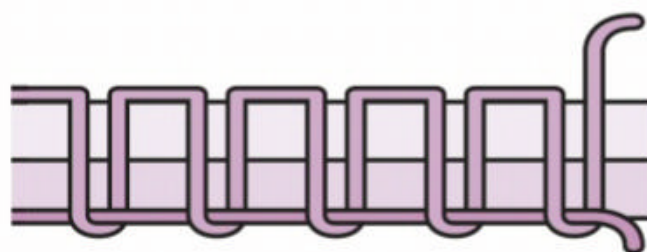

Top tension too loose or bobbin tension too tight

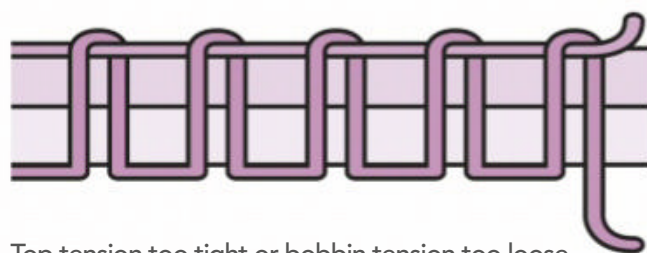

Top tension too tight or bobbin tension too loose

WHAT IS AVAXHOME?

AVAXHOME-

the biggest Internet portal,
providing you various content:
brand new books, trending movies,
fresh magazines, hot games,
recent software, latest music releases.

Unlimited satisfaction one low price

Cheap constant access to piping hot media

Protect your downloadings from Big brother

Safer, than torrent-trackers

18 years of seamless operation and our users' satisfaction

All languages

Brand new content

One site



AVXLIVE . ICU

AvaxHome - Your End Place

We have everything for all of your needs. Just open <https://avxlive.icu>

Top or spool tension

There is one place the tension can be adjusted on machines with standard bobbin cases. It is the only place tension can be easily adjusted on machines with a drop-in bobbin.

Many machines have a knob on the front of the machine to adjust tension. Most of the new electronic machines have a menu that will allow you to adjust the tension automatically by tapping the screen. Generally the higher the number, the tighter the tension will be.

TOP TIP

Threads need to pull equally in order to achieve good tension. If one thread is not pulling hard enough, turn its tension disc to the right to tighten. Turn left if the thread is pulling too hard in order to loosen it.

Bobbin Tension

A good starting point for bobbin tension is doing what is called the yo-yo test. To do this, remove your bobbin and case from the machine and, with the bobbin still in the case, hold the thread between your thumb and forefinger. Dangle the bobbin case in the air and gently bounce it up and down. If the bobbin and case fall to the ground, the tension is too loose.

If they do not drop at all, the tension is too tight. The case should drop just slightly each time you bounce it.

The bobbin also uses the “lefty-loosey and righty-tighty” adjustment method (see top right). Of course, this is just a starting point, and further adjustments may have to be made as you check your actual stitch quality.

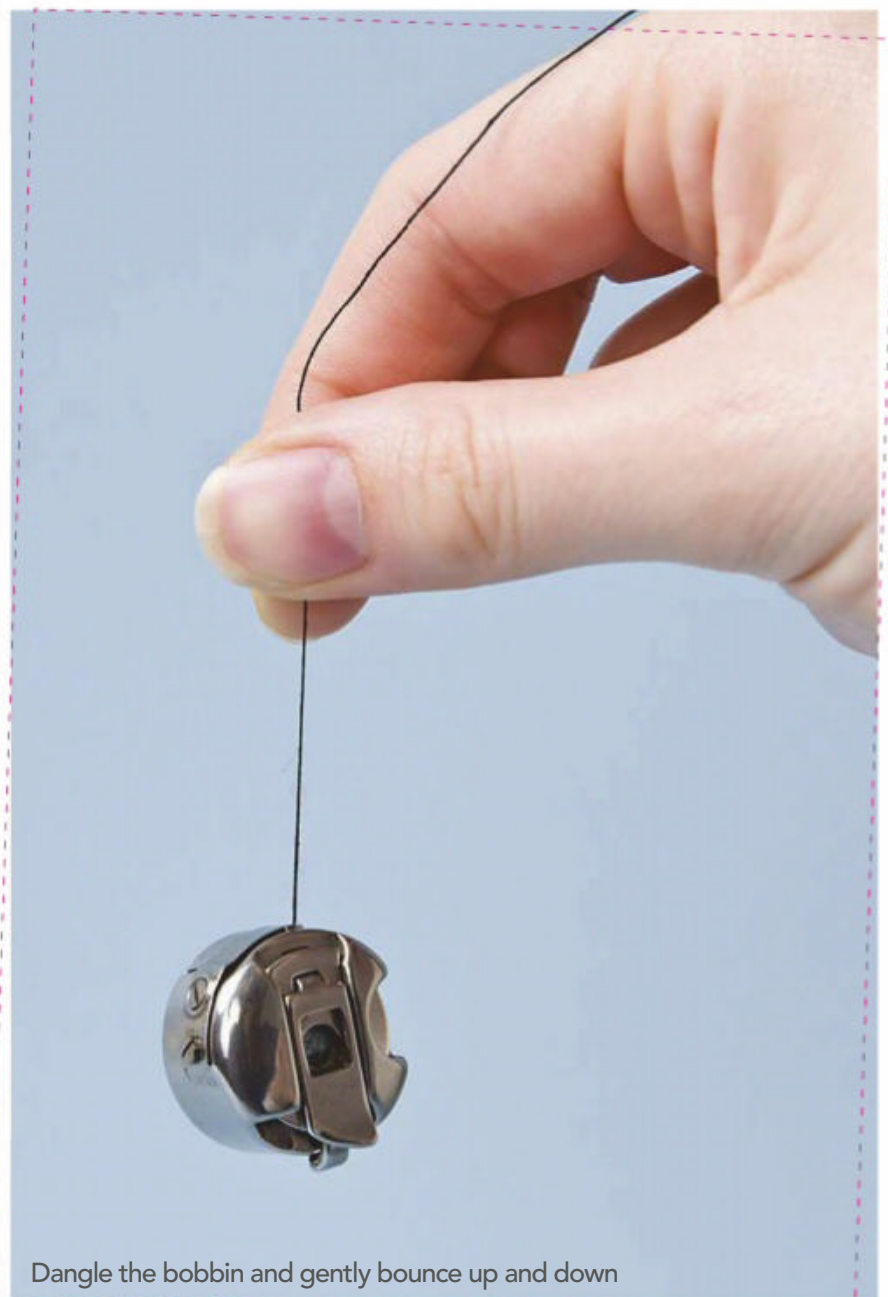

Dangle the bobbin and gently bounce up and down

MACHINE QUILTING: A GUIDE

Stitch Quality

One of the biggest challenges in machine quilting is maintaining a good stitch quality.

Problem #1

The bobbin thread lies flat on the back, or the top thread is visible on the back in the form of dots at the beginning and end of each stitch.



Back of quilt – top tension is too loose

Solution

- Increase the top tension or reduce the bobbin tension and retest.
- Use a larger-diameter needle.

Caution

If you increase the tension too much, you will see the top thread lying flat against the fabric. This is kind of like walking a tightrope, so make your adjustments in small increments.

Problem #2

The top thread lies flat on the top, or the bobbin thread is visible on the top in the form of small dots at the beginning and end of each stitch.



Front of quilt – top tension is too tight

Solution

- Decrease the top tension or increase the bobbin tension.
- Use a larger-diameter needle.

Caution

If you adjust the tension too much, you will see the bobbin thread lying flat on the back.

Hand placement

Hand placement is very important when machine quilting. I like to think of my hands as an embroidery hoop that moves the quilt sandwich through the machine.

If you place your hands on both sides of the needle, you will have much better control than if you place your hands at the edge of the extension table. Adjust the position of your hands depending on which direction you will be stitching. If you know that you are going to be stitching from left to right, for example, when you start stitching, place your right hand as close to the needle as possible, leaving extra space between your left hand and the needle. This will give you a larger range of motion.

Keep in mind that you are going to be starting and stopping many times, so the farther you can go between times when you have to move your hands, the more efficient you will be in the long run.

TOP TIP

In fact, it is possible to put the sandwich in a hoop and then hold onto it as you move the quilt sandwich (bottom right).



Good hand placement



Using an embroidery hoop

CHOOSING QUILTING DESIGNS

Sometimes less is more when it comes to your choice of design, says **Alex Anderson**

Traditional and innovative quilts have several things in common when you are considering which quilting designs to use. The guidelines generally hold true for both, and are also applicable to both machine and hand quilting. When I am deciding how to quilt my tops, I always

keep the guidelines in mind. However, as we all know, guidelines are subject to interpretation. Each quilt top needs to be considered individually. This makes the entire quilting journey an interesting and challenging experience from conception to conclusion.

Quilting guidelines

Will intricate quilting designs show? Not all quilts are candidates for awesome quilting designs. It is a sad day when you have spent the time stitching incredible quilted motifs only to find that they are lost in the pattern of the fabric. If a quilt is destined for fabulous quilting, make sure that the fabric you use is plain enough to let the quilting designs show. While planning the quilt, designate areas that will be highlighted with quilting. Solid fabrics are your best bet for those areas, or a printed fabric that reads almost as a solid will work.

If you are at all unsure, test the quilting on the fabric to see if it shows.

If any of your fabric is highly patterned and fancy quilting isn't going to show, I have two solutions that work quite well.

- Follow the printed fabric design to create your quilting design. When using this technique, make sure that there is an even density of quilting.
- Designs such as fans and cables are another nice solution. They are repetitive, so the brain can easily identify what the pattern is.



Fan

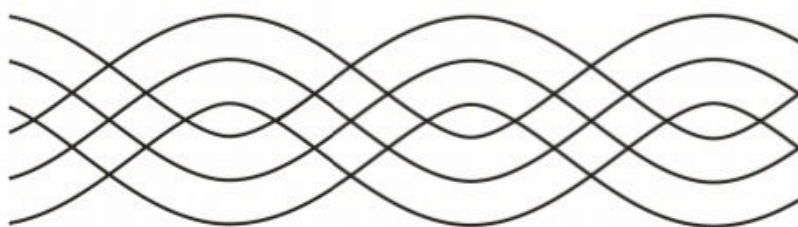

Cable

Many times new quilters are taught to quilt $\frac{1}{4}$ in from the sewn line. I believe this is so the quilter does not have to decide what to quilt and can simply get their hands going. The problem is that this technique can lead to some areas being heavily quilted while other areas are left without enough quilting.

Fill the space. Remember when you were in nursery school and your teacher would

constantly remind you to 'fill the space'?

The same holds true when deciding what designs to quilt. A design that is too small looks awkward and empty. If you are filling a specific area, for example, like an alternate solid-colour block, end the design about $\frac{1}{4}$ in from the sewn line. In addition to filling the space, this will help avoid quilting through the seam allowances.



Use an equal amount of quilting over the entire surface. If one area is tightly quilted and another area is left empty, not only will the quilt look odd, but it will not lie flat or hang straight.



Be careful not to over quilt, especially when machine quilting. The quilt might become stiff.



Use an adequate amount of quilting. Always read the batting manufacturer's recommended quilting density for the batting you are using, and follow their instructions for correct use.

It's okay, and in fact perfectly fine, to cross over seamlines of pieced units. Look how much more interesting it is to have a crosshatch grid crossing over pieced seamlines than $\frac{1}{4}$ in quilting would have been. Also, a border consisting of several units (inner borders and a main border) can be quilted with one motif. It is nice to mix geometric lines with soft, curved lines. That is why you will often see gridded backgrounds used with fancy motifs. They work well together and act as complements. The gridded background accentuates the intricate designs. Make sure the density of the grid is in proportion to the size and scale of the design.

Before you start to create your quilting designs, you need to know if your quilt will be quilted by hand or by machine. If you are designing for hand quilting, anything goes. If machine work is in the quilt's future, consider how many stop/starts you are creating.



Motif with grid quilting

PLANNING THE QUILTING ACROSS THE QUILT TOP

Successful quilting is all in the planning.
Christina Cameli shows you how

Facing a big quilt can be a little daunting, so always make sure you go in with a plan. I usually break up the quilt into rough sections and decide on an order for quilting them. I choose the sections based on the size of the quilt and the design I want to stitch.

I start with the centre areas whenever possible. This allows any fullness of the quilt to be pushed outwards as I go, making puckers less likely. I also appreciate finishing the hardest part while I am fresh and full of energy. It's all downhill from there!

As you can see from the suggested sections and quilting order shown below, I work in a counter-clockwise direction around the quilt's perimeter when I can, which aids in visibility.

If I'm stitching a directional design such as stretchy meandering motifs, I work in large columns or rows. Again, I start with the centre column and work outwards.

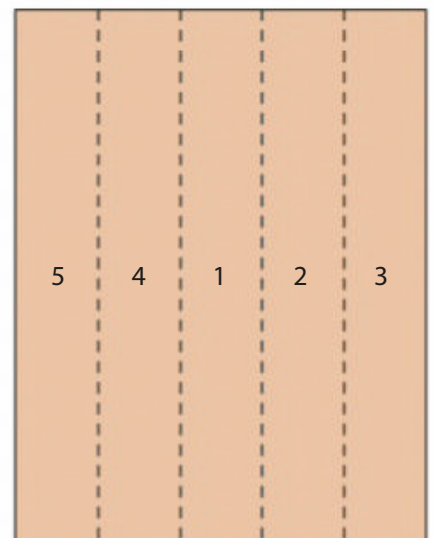
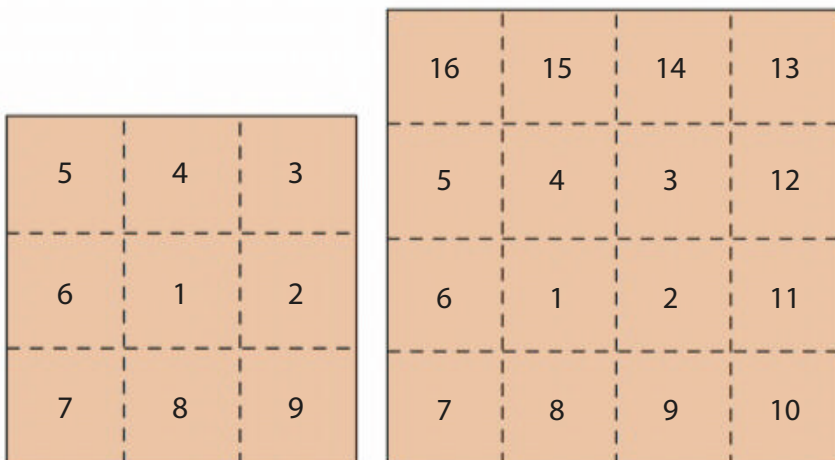

ENVISIONING THE QUILTING PATTERN

How to see what works before you start quilting by **Christina Cameli**

It can be difficult to envision how a quilting design will look on a quilt top. Sometimes you need to see it before you commit, in which case you can try one of these tactics.

Take a digital photo of the quilt (or a portion of the quilt) and print it out on regular printer paper. Sketch the design you are envisioning over the picture, as shown below. Print out a

few copies so that you can compare different quilting designs. Or for a technology-free option, lay a piece of clear vinyl over a portion of the quilt top. Sketch the quilting design on the vinyl with an erasable marker. Be very careful to keep the marker away from the edges and avoid smudging the ink onto your hands or the quilt.



Sketch your quilting design on a picture of the quilt top

BACKGROUND STITCHES

What makes a good background?
Hari Walner shares her secrets

Backgrounds are stitched in areas of fabric directly next to quilting designs you want to showcase. They give the

impression of receding behind a motif, much as a sky is in the background of a landscape painting.

Background know-how

Good background stitching adds texture and richness to your quilt without detracting from the featured quilting design. This texture is created by the quilting lines being closer to each other than the lines in the main quilting design. Some quilters refer to these background stitches as “fills”.

Background quilting can appear a bit darker than the quilted design, even when the same

thread is used for the design and the background. This is because lines of stitching create ditches when the quilt layers are compressed. The ditches create shadows. Background quilting has many lines of stitches close to each other, so more shadows are created. This slightly darker, textural effect is a lovely design element and can be used to draw attention to areas of your quilt.

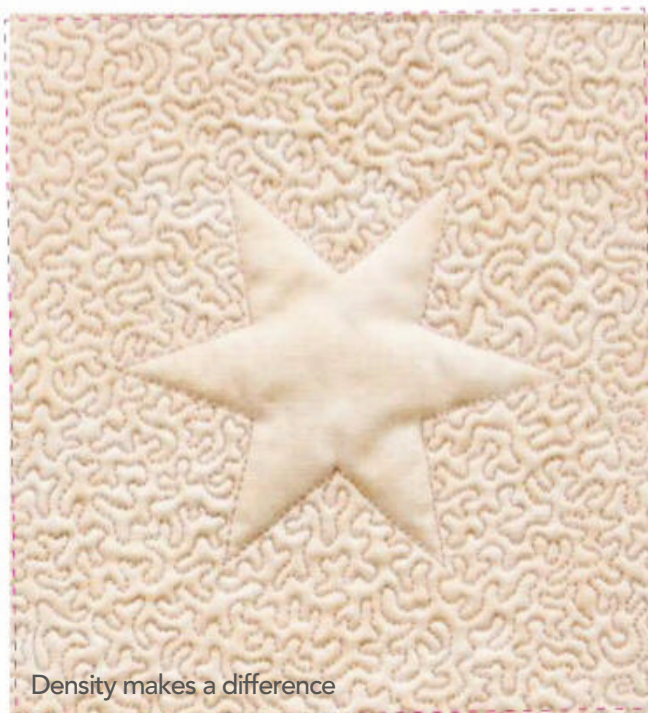

Density makes a difference

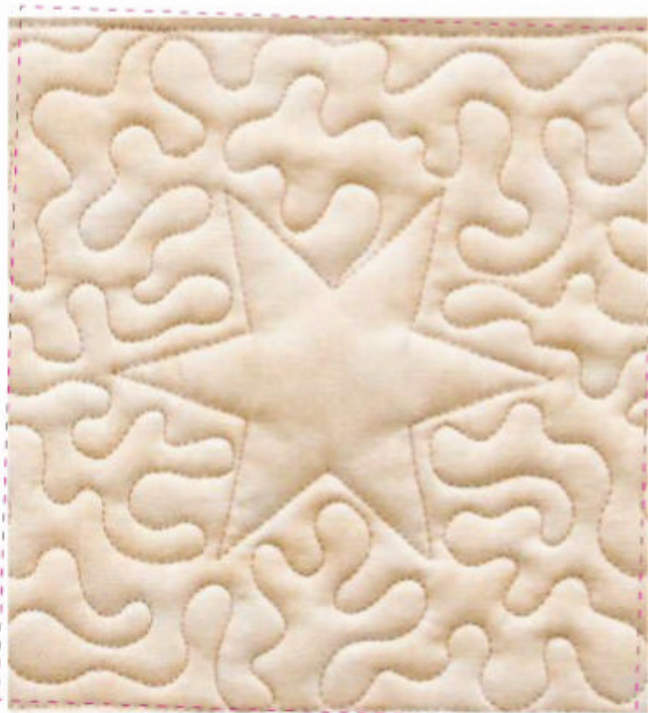

Showcase your quilt

When deciding how close to stitch the lines of quilting in your background, consider how large or complex the quilted designs are. Make your background quilting dense enough so your quilting design will stand out.

The goal is not to make these lines of background stitches as close to each other as possible, but to space them so they best show off your quilted designs. Very small

motifs need closer background stitching to increase the contrast. Larger motifs do not need the same density.

It often helps to experiment on a small sample piece with a portion of the quilting design to see how tightly you want to stitch the background. If your stitches are too widely spaced for the design, you miss an opportunity to accent the design.



Sample different motifs to make your choice

THE BEST WAY TO PRACTISE

Angela Walters shows us the best way to hone quilting skills (hint: repeat!)

Inevitably in every class I teach there comes a time where I have to break the bad news... to get better at machine quilting, you have to practise machine quilting.

Define a space

Define a practice area by quilting (or drawing) a square. It doesn't have to be any particular size or even a square. You just need clear boundaries to fill in with quilting. I tend to match the thread colour to the fabric, but this is your design decision!

Fill the space

Pick out a quilting design and commit to filling in the whole area without stopping or ripping out quilting (or erasing any drawn lines).

Ready. Set. Quilt!

This is where the fun happens! Start quilting (or drawing) a design in the area, trying to fill

it in as much as possible. The design you use doesn't matter.

Assess your quilting

Once finished, look over your sample and decide on one thing you want to improve during your next practice session. It could be anything, including, but not limited to:

- Quilting smoother lines.
- Keeping the stitch length consistent.
- Avoiding getting stuck.

It's important to only focus on one aspect of your quilting to improve. Setting just one goal gives you the ability to see improvement.

Repeat

Now that you have a goal in mind, practise until you are ready to work on a different goal. Try quilting just five minutes a day... whatever you think is manageable for you!



PATTERNS for every quilter...

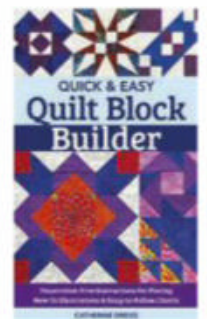
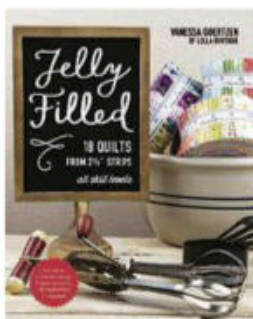
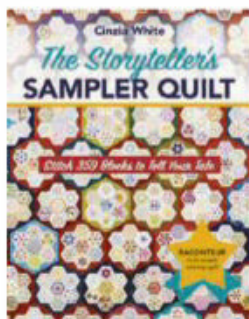
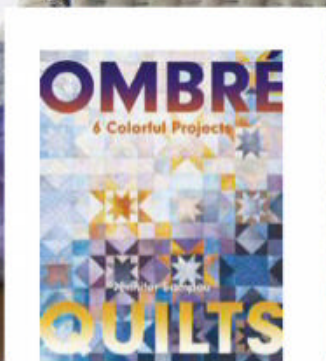

Available from Search Press.

Please go to Searchpress.com for details,

email: sales@searchpress.com, or call at Tel: 01892 510850



ALL STAR CAST

Conquer those unfinished quilt tops with our collection of essential techniques, tips and tricks for machine quilters

From setting up your machine to planning your design, we have advice from six experts from the quilting community to help get you started!

Featuring internationally acclaimed designers Angela Walters, Christina Cameli, Christine Maraccini, Don Linn, Alex Anderson and Hari Walner.



Christine Maraccini



Alex Anderson



Don Linn



Christina Cameli



Hari Walner



Angela Walters

